

IRFH5025PbF

HEXFET® Power MOSFET

| | | |
|--|------------|-----------------------------|
| V_{DS} | 250 | V |
| $R_{DS(on) \max}$ (@ $V_{GS} = 10V$) | 100 | mΩ |
| Q_g (typical) | 37 | nC |
| R_G (typical) | 1.6 | Ω |
| I_D (@ $T_{c(Bottom)} = 25^\circ C$) | 25 | A |

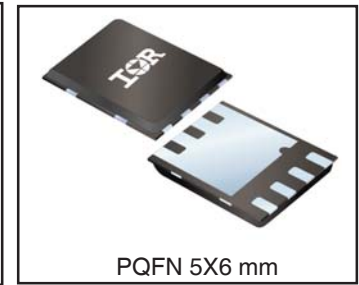
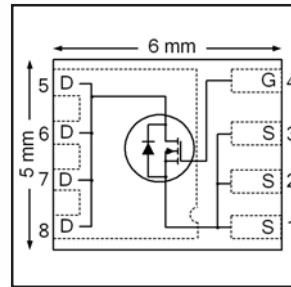

Applications

- Secondary Side Synchronous Rectification
- Inverters for DC Motors
- DC-DC Brick Applications
- Boost Converters

Features and Benefits

Features

| |
|--|
| Low $R_{DS(on)}$ |
| Low Thermal Resistance to PCB ($\leq 0.8^\circ C/W$) |
| 100% Rg tested |
| Low Profile (≤ 0.9 mm) |
| Industry-Standard Pinout |
| Compatible with Existing Surface Mount Techniques |
| RoHS Compliant Containing no Lead, no Bromide and no Halogen |
| MSL1, Industrial Qualification |

results in
⇒

Benefits

| |
|-----------------------------------|
| Lower Conduction Losses |
| Enable better thermal dissipation |
| Increased Reliability |
| Increased Power Density |
| Multi-Vendor Compatibility |
| Easier Manufacturing |
| Environmentally Friendlier |
| Increased Reliability |

| Orderable part number | Package Type | Standard Pack | | Note |
|-----------------------|----------------|---------------|----------|------|
| | | Form | Quantity | |
| IRFH5025TRPBF | PQFN 5mm x 6mm | Tape and Reel | 4000 | |
| IRFH5025TR2PBF | PQFN 5mm x 6mm | Tape and Reel | 400 | |

Absolute Maximum Ratings

| | Parameter | Max. | Units |
|-------------------------------------|---|--------------|---------------|
| V_{DS} | Drain-to-Source Voltage | 250 | V |
| V_{GS} | Gate-to-Source Voltage | ± 20 | |
| $I_D @ T_A = 25^\circ C$ | Continuous Drain Current, $V_{GS} @ 10V$ | 3.8 | A |
| $I_D @ T_A = 70^\circ C$ | Continuous Drain Current, $V_{GS} @ 10V$ | 3.1 | |
| $I_D @ T_{c(Bottom)} = 25^\circ C$ | Continuous Drain Current, $V_{GS} @ 10V$ | 25 | |
| $I_D @ T_{c(Bottom)} = 100^\circ C$ | Continuous Drain Current, $V_{GS} @ 10V$ | 16 | |
| $I_D @ T_{c(Top)} = 25^\circ C$ | Continuous Drain Current, $V_{GS} @ 10V$ | 5.7 | |
| $I_D @ T_{c(Top)} = 100^\circ C$ | Continuous Drain Current, $V_{GS} @ 10V$ | 3.7 | |
| I_{DM} | Pulsed Drain Current ① | 46 | |
| $P_D @ T_A = 25^\circ C$ | Power Dissipation ⑤ | 3.6 | W |
| $P_D @ T_{c(Top)} = 25^\circ C$ | Power Dissipation ④ | 8.3 | |
| | Linear Derating Factor ④ | 0.07 | W/ $^\circ C$ |
| T_J T_{STG} | Operating Junction and Storage Temperature Range | -55 to + 150 | $^\circ C$ |

Notes ① through ⑤ are on page 8

www.irf.com

Static @ $T_J = 25^\circ\text{C}$ (unless otherwise specified)

| | Parameter | Min. | Typ. | Max. | Units | Conditions |
|------------------------------|--------------------------------------|------|------|------|------------|--|
| BV_{DSS} | Drain-to-Source Breakdown Voltage | 250 | — | — | V | $V_{GS} = 0V, I_D = 250\mu A$ |
| $\Delta BV_{DSS}/\Delta T_J$ | Breakdown Voltage Temp. Coefficient | — | 0.31 | — | V/°C | Reference to $25^\circ\text{C}, I_D = 1mA$ |
| $R_{DS(on)}$ | Static Drain-to-Source On-Resistance | — | 84 | 100 | m Ω | $V_{GS} = 10V, I_D = 5.7A$ ③ |
| $V_{GS(th)}$ | Gate Threshold Voltage | 3.0 | — | 5.0 | V | $V_{DS} = V_{GS}, I_D = 150\mu A$ |
| $\Delta V_{GS(th)}$ | Gate Threshold Voltage Coefficient | — | -13 | — | mV/°C | |
| I_{DSS} | Drain-to-Source Leakage Current | — | — | 20 | μA | $V_{DS} = 250V, V_{GS} = 0V$ |
| | | — | — | 250 | | $V_{DS} = 250V, V_{GS} = 0V, T_J = 125^\circ\text{C}$ |
| I_{GSS} | Gate-to-Source Forward Leakage | — | — | 100 | nA | $V_{GS} = 20V$ |
| | Gate-to-Source Reverse Leakage | — | — | -100 | | $V_{GS} = -20V$ |
| g_{fs} | Forward Transconductance | 13 | — | — | S | $V_{DS} = 50V, I_D = 5.7A$ |
| Q_g | Total Gate Charge | — | 37 | 56 | nC | $V_{DS} = 125V$ $V_{GS} = 10V$ $I_D = 5.7A$ See Fig.17 & 18 |
| Q_{gs1} | Pre-Vth Gate-to-Source Charge | — | 8.3 | — | | |
| Q_{gs2} | Post-Vth Gate-to-Source Charge | — | 1.9 | — | | |
| Q_{gd} | Gate-to-Drain Charge | — | 13 | — | | |
| Q_{godr} | Gate Charge Overdrive | — | 14 | — | | |
| Q_{sw} | Switch Charge ($Q_{gs2} + Q_{gd}$) | — | 15 | — | | |
| Q_{oss} | Output Charge | — | 11 | — | nC | $V_{DS} = 16V, V_{GS} = 0V$ |
| R_G | Gate Resistance | — | 1.6 | — | Ω | |
| $t_{d(on)}$ | Turn-On Delay Time | — | 9.0 | — | ns | $V_{DD} = 125V, V_{GS} = 10V$ $I_D = 5.7A$ $R_G = 1.8\Omega$ See Fig.15 |
| t_r | Rise Time | — | 6.3 | — | | |
| $t_{d(off)}$ | Turn-Off Delay Time | — | 17 | — | | |
| t_f | Fall Time | — | 6.1 | — | | |
| C_{iss} | Input Capacitance | — | 2150 | — | pF | $V_{GS} = 0V$ $V_{DS} = 50V$ $f = 1.0MHz$ |
| C_{oss} | Output Capacitance | — | 150 | — | | |
| C_{rss} | Reverse Transfer Capacitance | — | 40 | — | | |

Avalanche Characteristics

| | Parameter | Typ. | Max. | Units |
|----------|---------------------------------|------|------|-------|
| E_{AS} | Single Pulse Avalanche Energy ② | — | 320 | mJ |
| I_{AR} | Avalanche Current ① | — | 5.7 | A |

Diode Characteristics

| | Parameter | Min. | Typ. | Max. | Units | Conditions |
|----------|---|---|------|------|-------|---|
| I_S | Continuous Source Current (Body Diode) | — | — | 5.7 | A | MOSFET symbol showing the integral reverse p-n junction diode. |
| I_{SM} | Pulsed Source Current (Body Diode) ① | — | — | 46 | | |
| V_{SD} | Diode Forward Voltage | — | — | 1.3 | V | $T_J = 25^\circ\text{C}, I_S = 5.7A, V_{GS} = 0V$ ③ |
| t_{rr} | Reverse Recovery Time | — | 55 | 83 | ns | $T_J = 25^\circ\text{C}, I_F = 5.7A, V_{DD} = 125V$ |
| Q_{rr} | Reverse Recovery Charge | — | 510 | 770 | nC | $di/dt = 500A/\mu s$ ③ |
| t_{on} | Forward Turn-On Time | Time is dominated by parasitic Inductance | | | | |

Thermal Resistance

| | Parameter | Typ. | Max. | Units |
|--------------------------|-----------------------|------|------|-------|
| $R_{\theta JC}$ (Bottom) | Junction-to-Case | 0.5 | 0.8 | °C/W |
| $R_{\theta JC}$ (Top) | Junction-to-Case ④ | — | 15 | |
| $R_{\theta JA}$ | Junction-to-Ambient ⑤ | — | 35 | |
| $R_{\theta JA}$ (<10s) | Junction-to-Ambient ⑤ | — | 22 | |

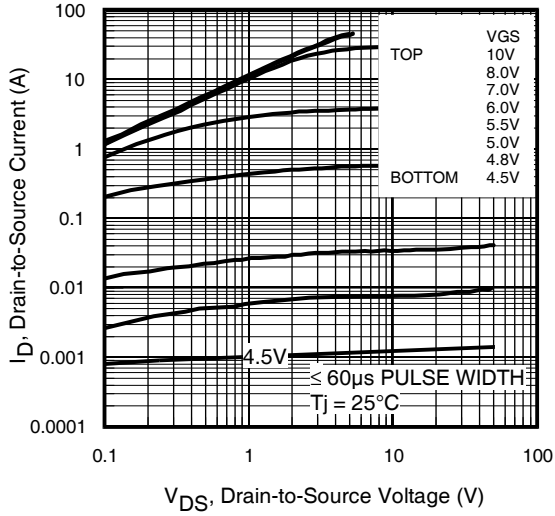

Fig 1. Typical Output Characteristics

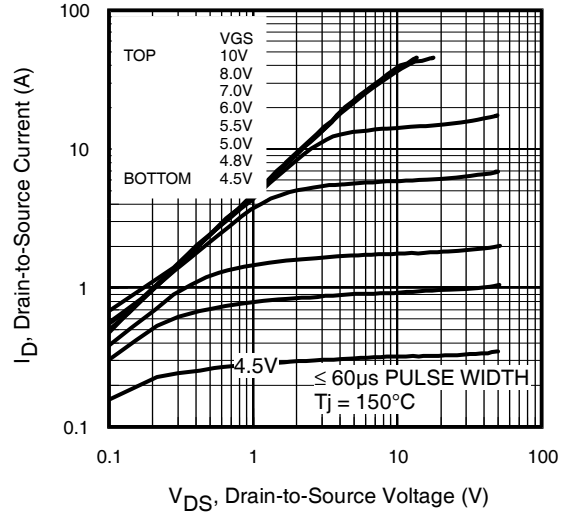

Fig 2. Typical Output Characteristics

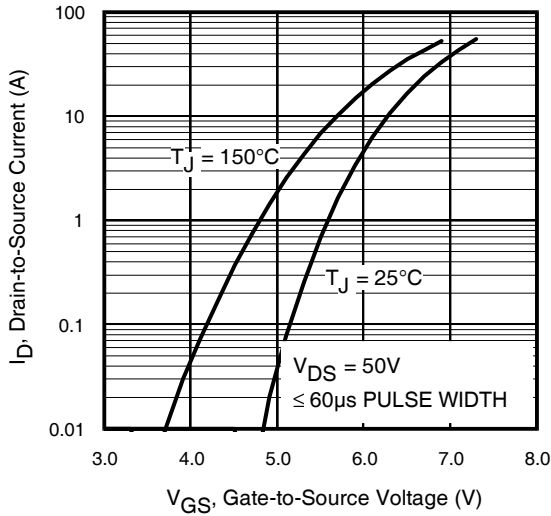

Fig 3. Typical Transfer Characteristics

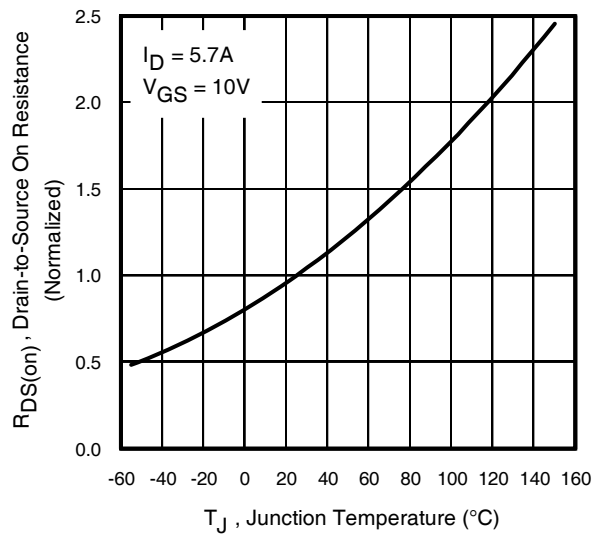

Fig 4. Normalized On-Resistance Vs. Temperature

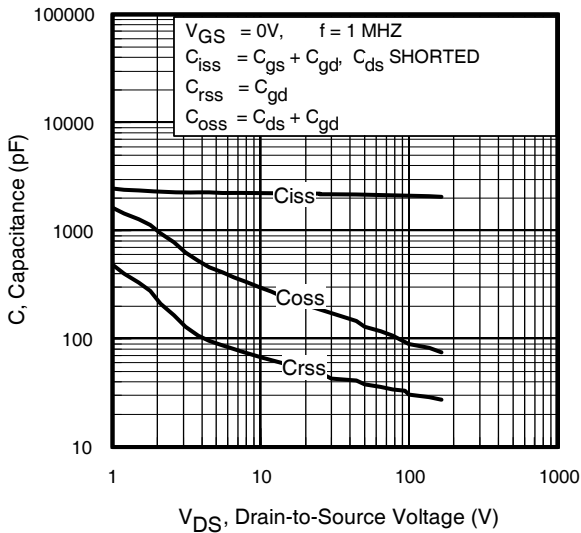

Fig 5. Typical Capacitance Vs. Drain-to-Source Voltage
www.irf.com

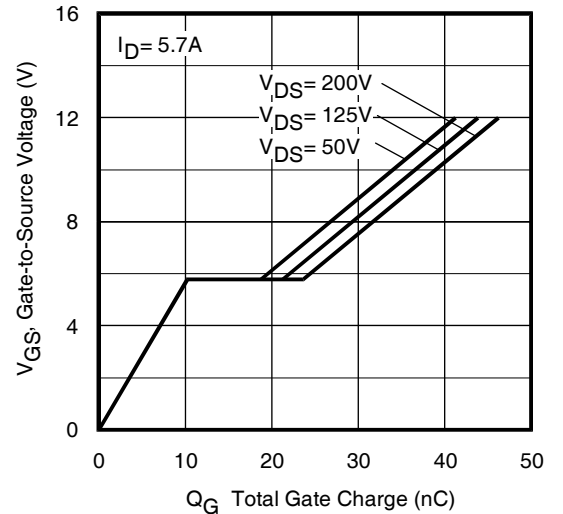

Fig 6. Typical Gate Charge Vs. Gate-to-Source Voltage

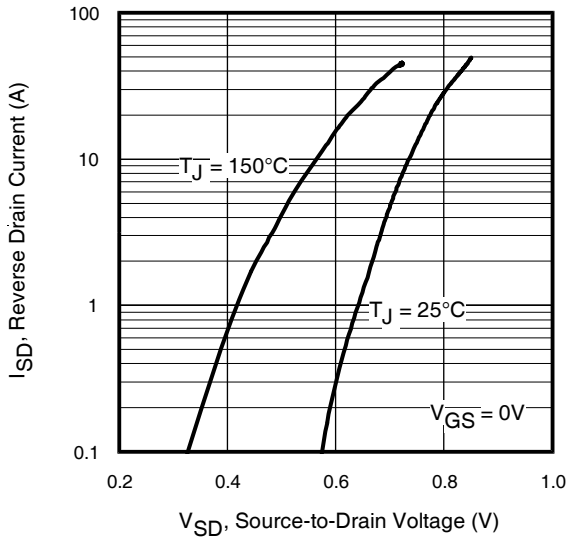

Fig 7. Typical Source-Drain Diode Forward Voltage

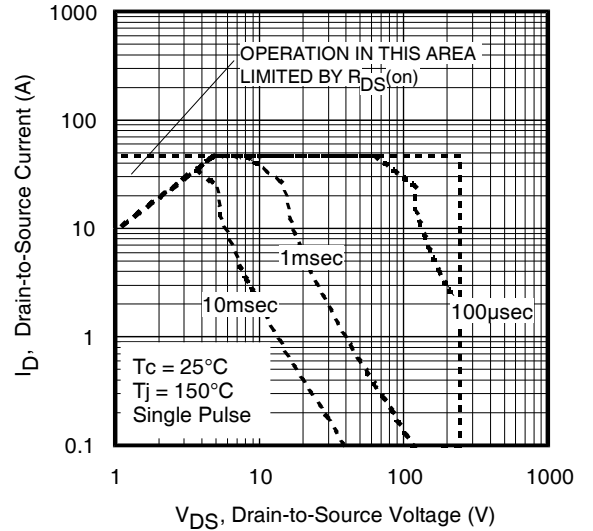

Fig 8. Maximum Safe Operating Area

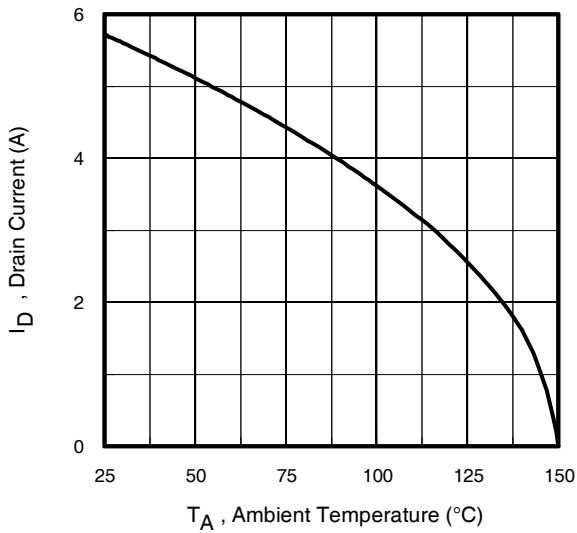

Fig 9. Maximum Drain Current Vs. Case (Top) Temperature

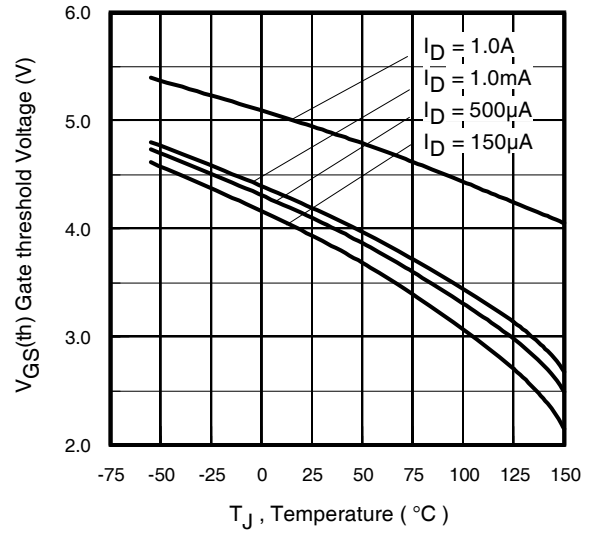

Fig 10. Threshold Voltage Vs. Temperature

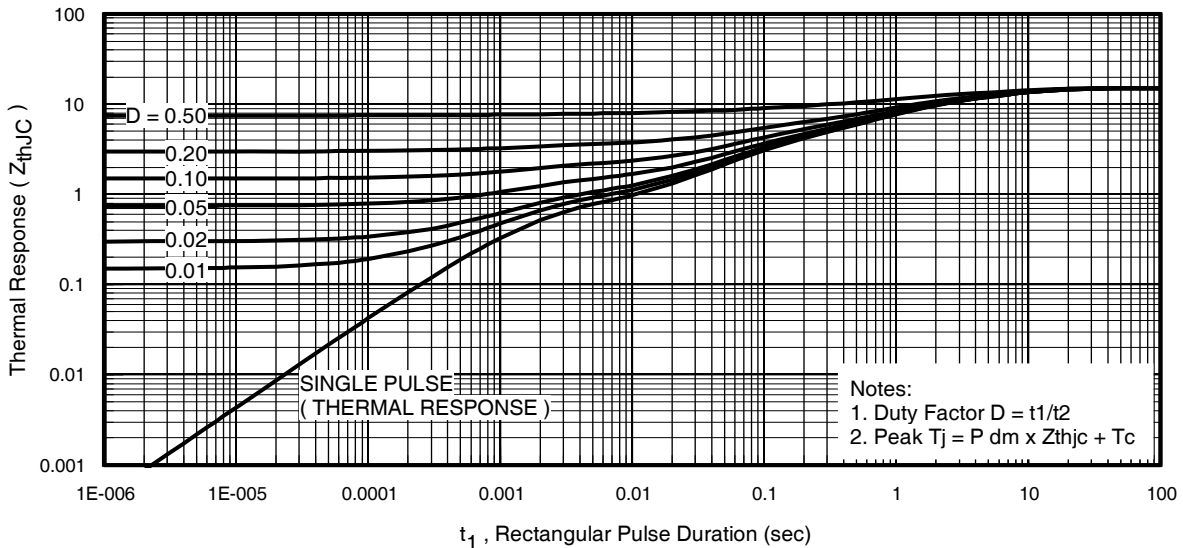

Fig 11. Maximum Effective Transient Thermal Impedance, Junction-to-Case (Top)

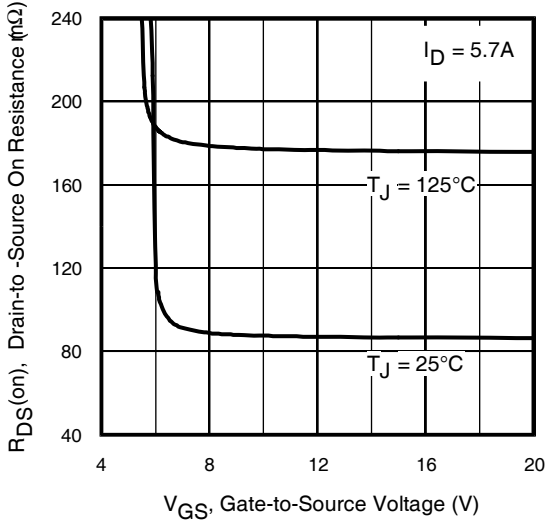

Fig 12. On-Resistance vs. Gate Voltage

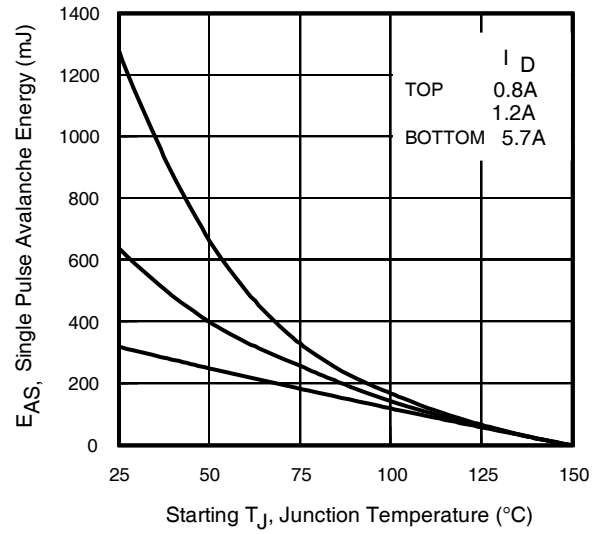

Fig 13. Maximum Avalanche Energy vs. Drain Current

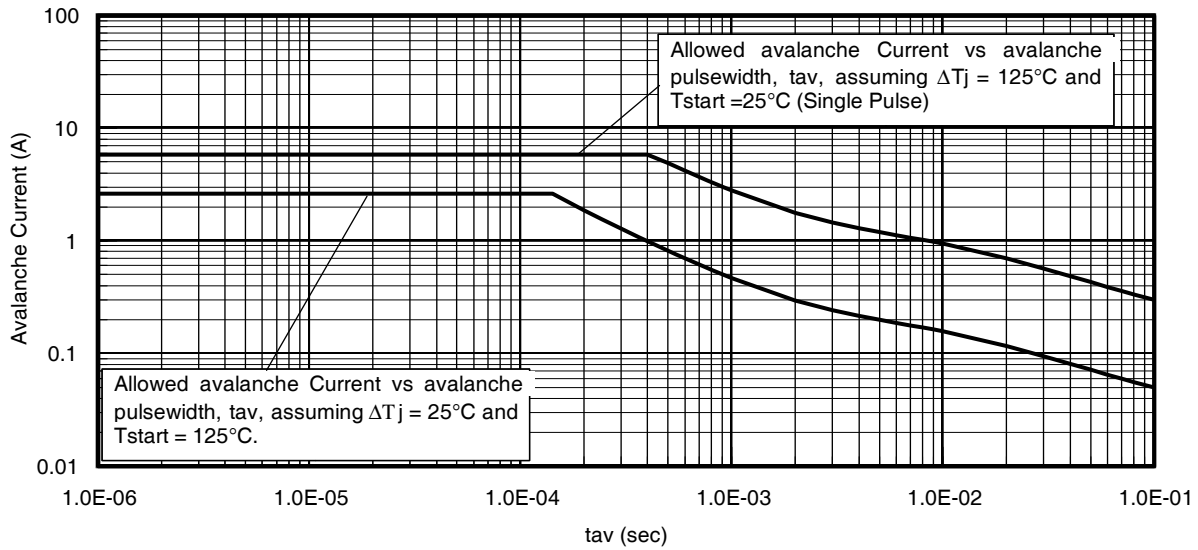

Fig 14. Typical Avalanche Current vs. Pulsewidth

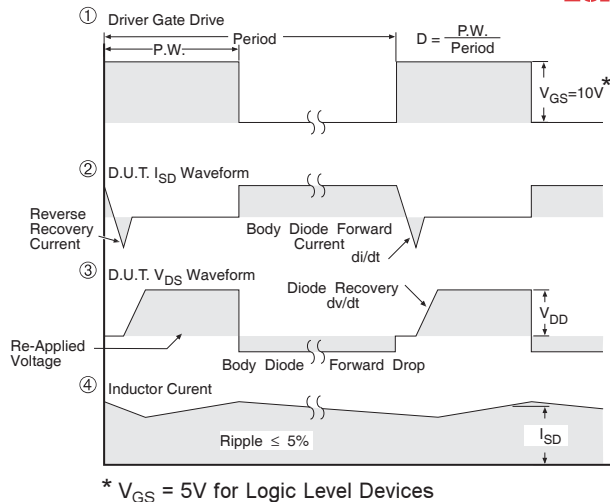
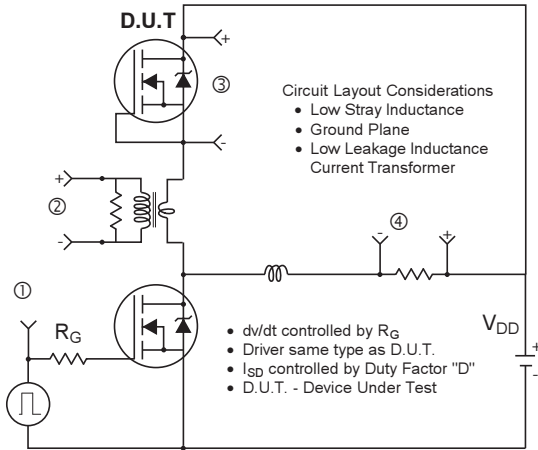

Fig 15. Peak Diode Recovery dv/dt Test Circuit for N-Channel HEXFET[®] Power MOSFETs

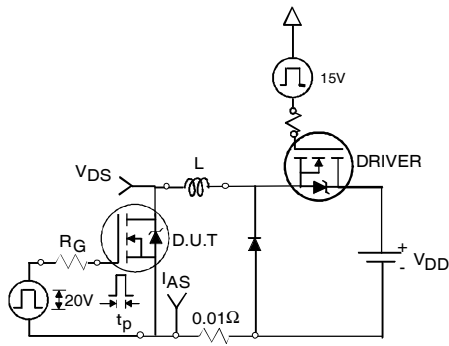

Fig 16a. Unclamped Inductive Test Circuit

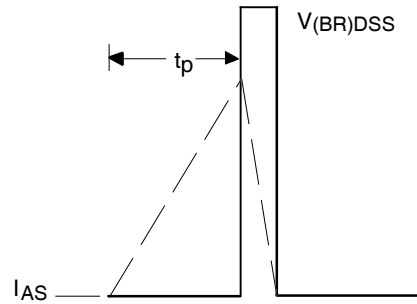

Fig 16b. Unclamped Inductive Waveforms

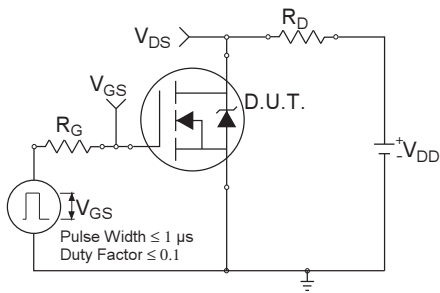

Fig 17a. Switching Time Test Circuit

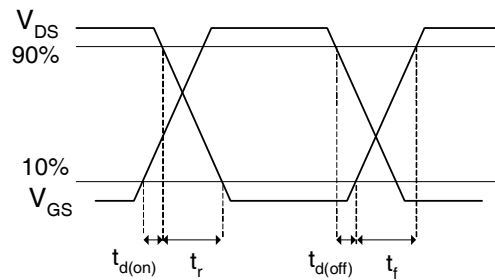

Fig 17b. Switching Time Waveforms

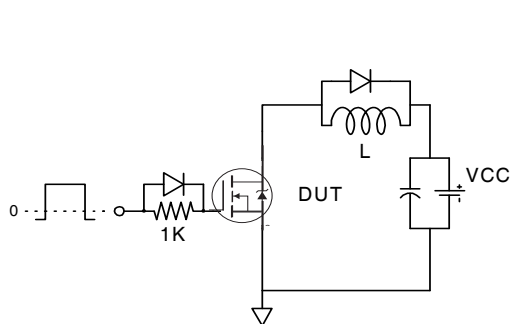

Fig 18a. Gate Charge Test Circuit

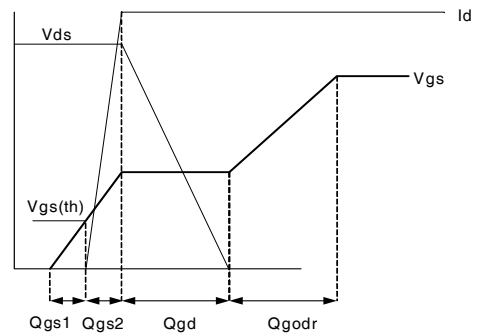
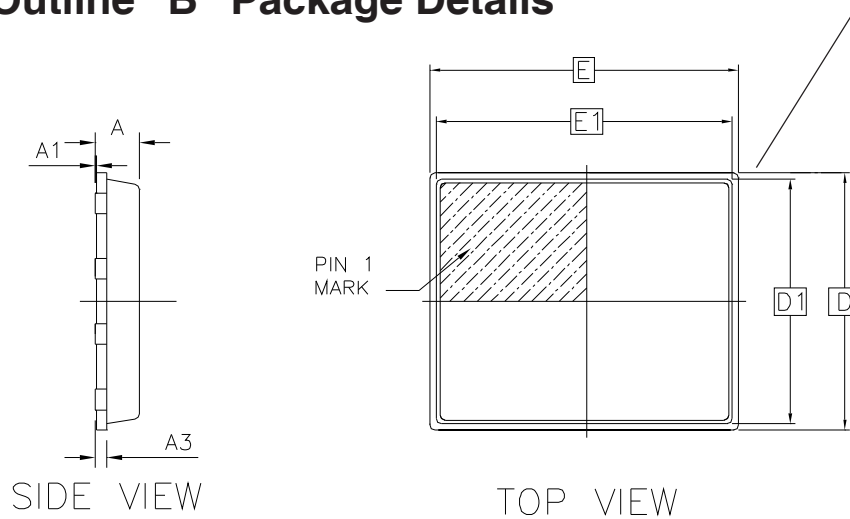
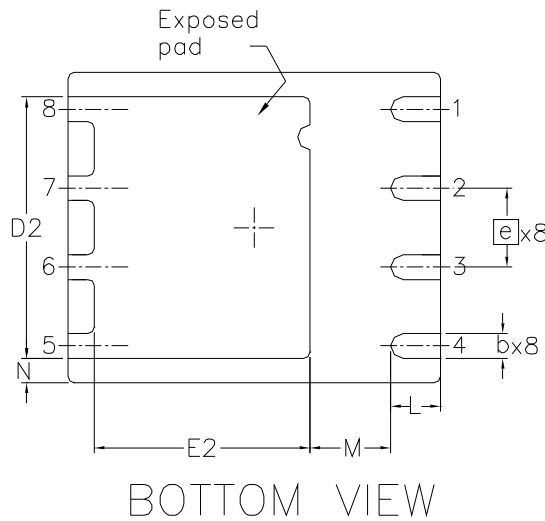

Fig 18b. Gate Charge Waveform

PQFN 5x6 Outline "B" Package Details



| OUTLINE PQFN 5x6B | | | |
|-------------------|------|-------|------|
| DIM SYMBOL | MIN | NOM | MAX |
| A | 0.80 | 0.83 | 0.90 |
| A1 | 0 | 0.020 | 0.05 |
| A3 | | 0.20 | REF |
| b | 0.35 | 0.40 | 0.47 |
| D | | 5.00 | BSC |
| D1 | | 4.75 | BSC |
| D2 | 4.10 | 4.21 | 4.30 |
| e | | 1.27 | BSC |
| E | | 6.00 | BSC |
| E1 | | 5.75 | BSC |
| E2 | 3.38 | 3.48 | 3.58 |
| L | 0.70 | 0.80 | 0.90 |
| M | | 1.30 | REF |
| N | | 0.40 | REF |



For footprint and stencil design recommendations, please refer to application note AN-1154 at <http://www.irf.com/technical-info/appnotes/an-1154.pdf>

PQFN 5x6 Outline "B" Part Marking

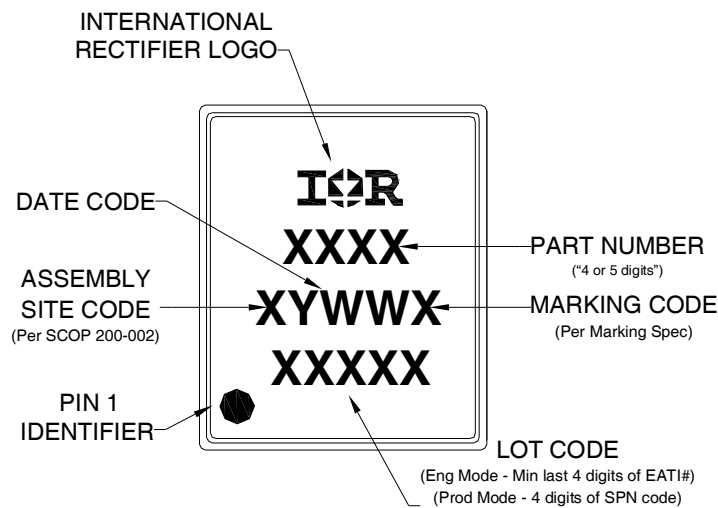

Note: For the most current drawing please refer to IR website at: <http://www.irf.com/package/>
www.irf.com

PQFN Tape and Reel

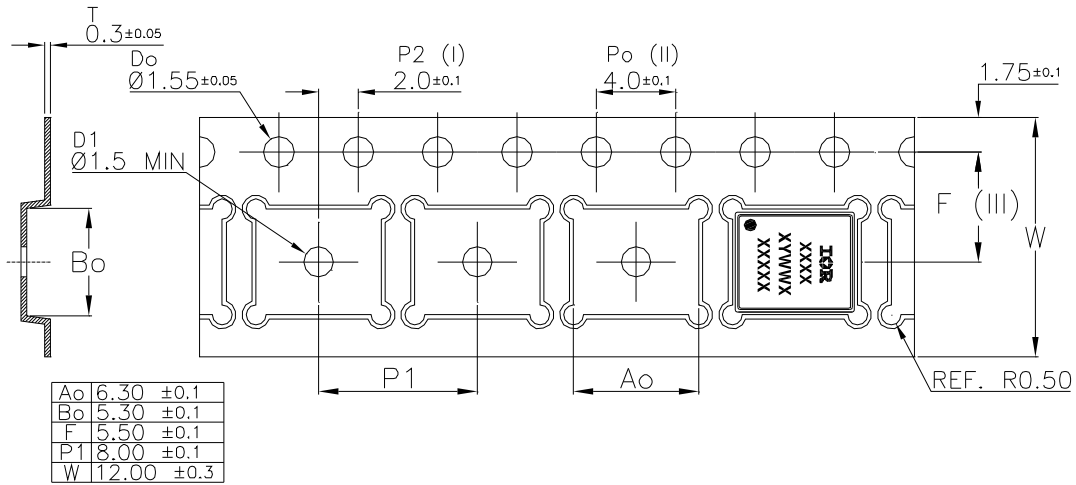

Note: For the most current drawing please refer to IR website at: <http://www.irf.com/package/>

Qualification information[†]

| | | |
|----------------------------|---|--|
| Qualification level | Industrial ^{††} (per JEDEC JESD47F ^{†††} guidelines) | |
| Moisture Sensitivity Level | PQFN 5mm x 6mm | MSL1 (per JEDEC J-STD-020D ^{†††}) |
| RoHS compliant | Yes | |

[†] Qualification standards can be found at International Rectifier's web site

<http://www.irf.com/product-info/reliability>

^{††} Higher qualification ratings may be available should the user have such requirements.

Please contact your International Rectifier sales representative for further information:

<http://www.irf.com/whoto-call/salesrep/>

^{†††} Applicable version of JEDEC standard at the time of product release.

Notes:

- ① Repetitive rating; pulse width limited by max. junction temperature.
- ② Starting $T_J = 25^\circ\text{C}$, $L = 19.6\text{mH}$, $R_G = 25\Omega$, $I_{AS} = 5.7\text{A}$.
- ③ Pulse width $\leq 400\mu\text{s}$; duty cycle $\leq 2\%$.
- ④ R_θ is measured at T_J of approximately 90°C .
- ⑤ When mounted on 1 inch square 2 oz copper pad on 1.5x1.5 in. board of FR-4 material.

Data and specifications subject to change without notice.

International
IR Rectifier

IR WORLD HEADQUARTERS: 101N.Sepulveda blvd, El Segundo, California 90245, USA Tel: (310) 252-7105
TAC Fax: (310) 252-7903

Visit us at www.irf.com for sales contact information.09/2012