

Filters for Communication Lines

Analog Systems and Control Lines

Series/Type: **B84312**

Date: January 2004

© EPCOS AG 2015. Reproduction, publication and dissemination of this publication, enclosures hereto and the information contained therein without EPCOS' prior express consent is prohibited.

EPCOS AG is a TDK Group Company.

Passband up to 300 kHz
Stopband attenuation up to 40 GHz



Features

- Use of coaxial feed-through capacitors on input and output
- Single or current-balanced chokes depending on requirement
- Insertion loss to CISPR 17
- Also available with integrated EMP protection

Installation

Single filters are attached directly to the shielding wall. Larger numbers can be housed in filter cabinets or boxes. Various models and the matching flexible connector fittings are available.

Mechanical design

The electrical components are incorporated in an RF-tight case of tin-plated sheet steel. Filters are available for 2 or 20 lines and for upright or flat installation on shielding wall.

Model	Installation		Filter selection
B84312C	Upright	Space-saving solution for installing a number of different filters.	B84312C*B (2-line) B84312C*H (20-line)
B84312F	Flat	Low profile and thus advantage especially for just one or a few filters.	B84312F*B (2-line)

Filter applications

The following standard filters are designed for the most common applications; customized models can be produced for differing requirements.

Passband kHz	Z_L Ω	I_R A	Application	Circuit diagram	No. of lines	Series B84312
DC ... 3.4	600	0.1	Standard filters for telephone systems	1	2 20	+0020B*** C0020H***
DC ... 3.4	600	0.1	Telephone systems for enhanced requirements (stopband attenuation of 100 dB above 10 kHz)	3	2 20	+0090B*** C0090H***
DC ... 50	600	0.1	Filters for telephone systems and modem cables, conditionally for control lines with critical signal rise times	1	2 20	+0040B*** C0040H***
DC ...120	150	0.1	Data signals with balanced signal transmission mode as used	2	2 20	+0050B*** C0050H***
DC ... 300	150	0.1	by modems or interfaces RS 485 up to 9600 Baud and/or RS 422 up to 19200 Baud	2	2 20	+0060B*** C0060H***
DC ... 120	100	2	Smoke detectors with serial data transmission in bus systems and remote power feeding, temperature switches, 24 V emergency lighting, DC motors	2	2 20	+0050B*** C0050H***
–	–	3	24-V emergency lighting, DC motors, signal and control lines	2	2 20	+0050B*** C0050H***
–	–	1	Universal filters for signal and control lines with up to 1 A	1	2 20	+0030B*** C0030H***
–	–	1	Control lines with up to 1 A and enhanced attenuation requirements	3	2 20	+0100B*** C0100H***

+ : C = upright installation, F = flat installation

Circuit diagrams

The diagrams each show a circuit of a 2-line filter.
 In the series of 20-line filters there are 10 of them in each case.

Circuit diagram 1

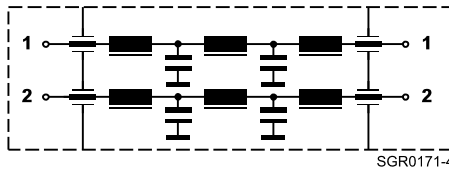

Circuit diagram 2

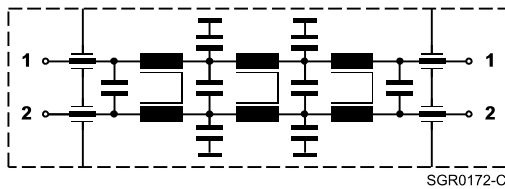

Circuit diagram 3

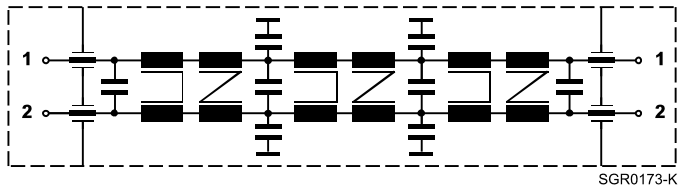

Note on circuit diagrams 2 and 3:

These filters are mounted with current-compensated chokes. Make sure that the forward and return line are routed paired through one filter.

General technical data

Rated voltage	$V_{R,AC}$	100	V	
Rated voltage	$V_{R,DC}$	100	V	
Rated frequency	f_R			Pass bandwidth at Z_L
Rated current	I_R	See characteristics		$T_A = 40\text{ °C}$
Line impedance	Z_L	See characteristics		
Test voltage	V_{test}	250 VDC, 2 s 250 VDC, 2 s		Line/line Line/case
Maximum DC resistance	R_{max}	See characteristics		Per line
Permissible ambient temperature	T_A	-25/+40	°C	
Climatic category (EN 60068-1)		25/085/56		-25 °C/+85 °C/56 days damp heat test
Weight		560 4.5	g kg	2-line filters 20-line filters
Mechanical version		C F		Upright for 2- and 20-line filters Flat for 2-line filters

Filters with EMP protection:

Nominal DC spark-over voltage	V_{sdcN}	<500	V	Per line
Surge response voltage		<800 <800	V V	At 1 kV/μs At 1 kV/ns
Nominal surge current (8/20 μs)		5/10	kA	
Suppression condition		$I \leq I_R$		

Maximum voltage on filter output for filters with EMP protection

Series	B84312	...0020+1** ...0090+1**	...0030+1** ...0100+1**	...0040+1**	...0050+1**	...0060+1**
Pulse shape in symmetrical circuit						
dv/dt = 0.1	kV/μs	2 V	360 V	8 V	3 V	12 V
dv/dt = 1	kV/μs	1 V	60 V	3 V	2 V	9 V
dv/dt = 1	kV/ns ¹⁾	0.5 V	2 V	0.5 V	0.5 V	1.2 V
Nominal surge current (8/20 μs)		5 V	290 V	12 V	10 V	12 V
Pulse shape in unsymmetrical circuit						
dv/dt = 0.1	kV/μs	50 V	700 V	250 V	120 V	280 V
dv/dt = 1	kV/μs	35 V	130 V	60 V	25 V	30 V
dv/dt = 1	kV/ns ¹⁾	1 V	5 V	3 V	1 V	1 V
Nominal surge current (8/20 μs)		20 V	200 V	110 V	25 V	50 V

1) Typical test pulse: rise time 10 ns, time to half value 1500 ns, charge voltage min. 50 kV, source impedance 90 Ω

Characteristics and ordering codes

I_R	Pass bandwidth kHz	Z_L Ω	R_{max} Per line Ω	Circuit diagram	Number of lines	Ordering code
A						
0.1	DC ... 3.4	600	11	1	2	B84312C0020B*03
0.1	DC ... 3.4	600	11	1	2	B84312F0020B*03
0.1	DC ... 3.4	600	11	1	20	B84312C0020H*03
1	— ²⁾	³⁾	0.4	1	2	B84312C0030B*03
1	— ²⁾	³⁾	0.4	1	2	B84312F0030B*03
1	— ²⁾	³⁾	0.4	1	20	B84312C0030H*03
0.1	DC ... 50	600	1.1	1	2	B84312C0040B*01
0.1	DC ... 50	600	1.1	1	2	B84312F0040B*01
0.1	DC ... 50	600	1.1	1	20	B84312C0040H*01
0.1	DC ... 120	150	4.4	2	2	B84312C0050B*01
0.1	DC ... 120	150	4.4	2	2	B84312F0050B*01
0.1	DC ... 120	150	4.4	2	20	B84312C0050H*01
2	DC ... 120	100	0.4	2	2	B84312C0050B*21
2	DC ... 120	100	0.4	2	2	B84312F0050B*21
2	DC ... 120	100	0.4	2	20	B84312C0050H*21
3	— ²⁾	³⁾	0.2	2	2	B84312C0050B*31
3	— ²⁾	³⁾	0.2	2	2	B84312F0050B*31
3	— ²⁾	³⁾	0.2	2	20	B84312C0050H*31
0.1	DC ... 300	150	1.0	2	2	B84312C0060B*01
0.1	DC ... 300	150	1.0	2	2	B84312F0060B*01
0.1	DC ... 3.4	600	17	3	2	B84312C0090B*04
0.1	DC ... 3.4	600	17	3	2	B84312F0090B*04
0.1	DC ... 3.4	600	17	3	20	B84312C0090H*04
1	— ²⁾	³⁾	0.6	3	2	B84312C0100B*03
1	— ²⁾	³⁾	0.6	3	2	B84312F0100B*03
1	— ²⁾	³⁾	0.6	3	20	B84312C0100H*03

*: 0 = Standard filters

1 = Filters with EMP protection

2) Control line filters, not matched

3) Not specified

Insertion loss α_e in passband (typical)

Measurement circuit

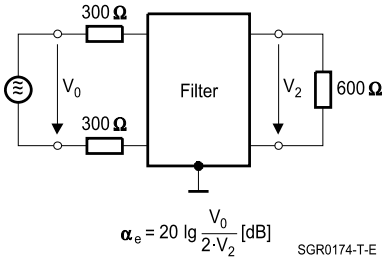

Symmetrical measurement circuit
with $Z_L = 600 \Omega$

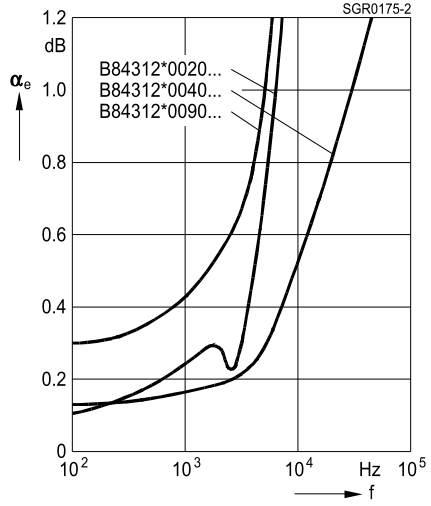

Measurement circuit

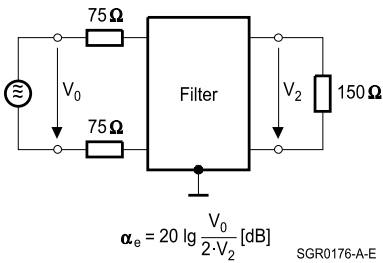

Symmetrical measurement circuit
with $Z_L = 150 \Omega$

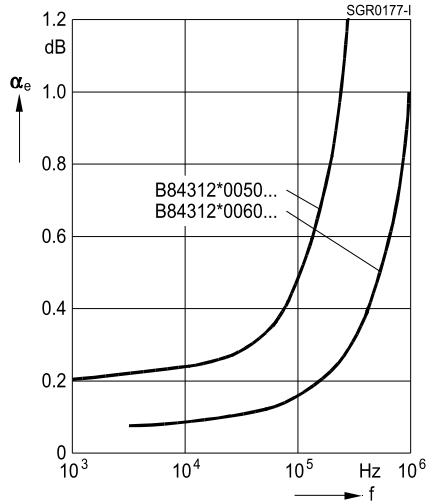

Unsymmetrical measurement (common-mode-rejection) in passband

Measurement circuit

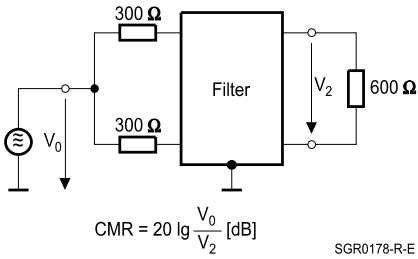

Filter with $Z_L = 600 \Omega$

CMR >40 dB in passband

Insertion loss α_e in stopband (typical)

Measurement circuit

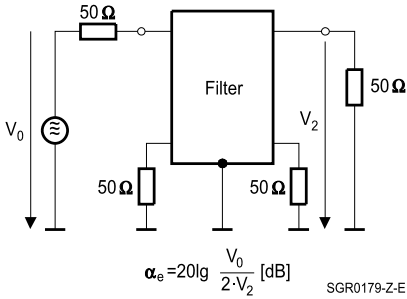

Unsymmetrical measurement circuit

Measurement circuit

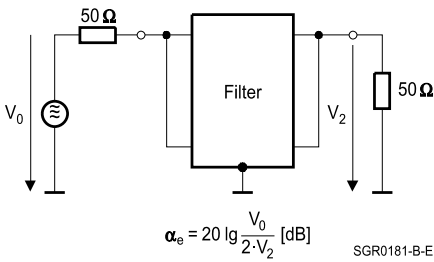

Asymmetrical measurement to MIL-STD-220A

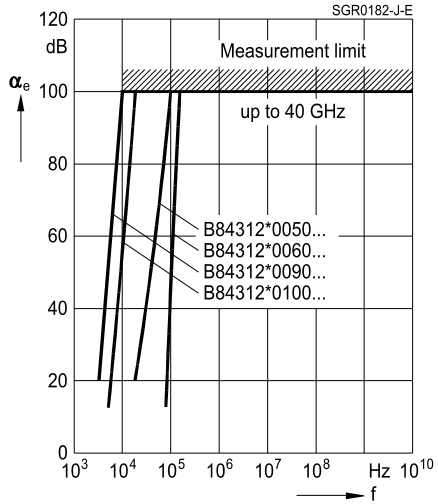
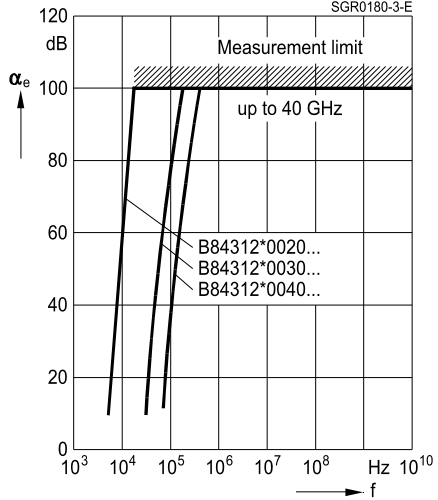

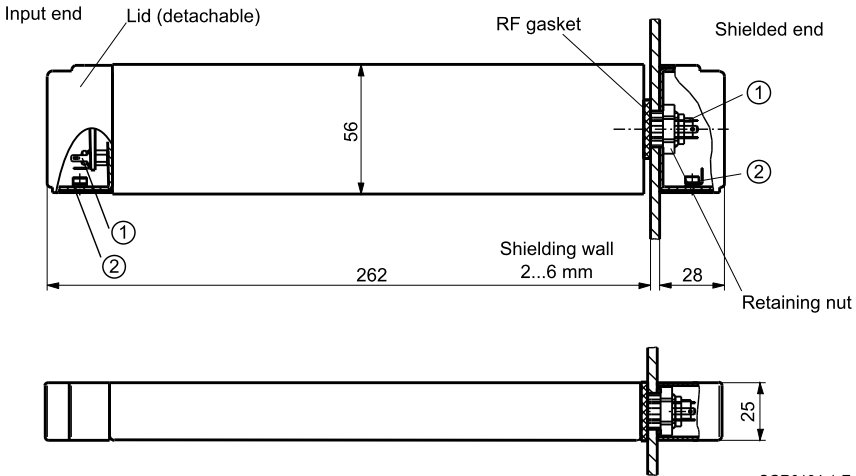
Dimensional drawings
2-line filters, upright installation

SGR0184-1-E

- ① Line connections at both ends:
2 x tab connectors for receptacle 2.8 x 0.5 (in accessory bag)
- ② Strain relief with ground connection for cable diameter 4.5 ... 6 mm

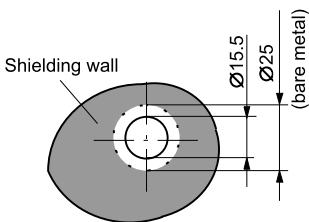
Hole for installation in shielding wall

SGR0185-9-E

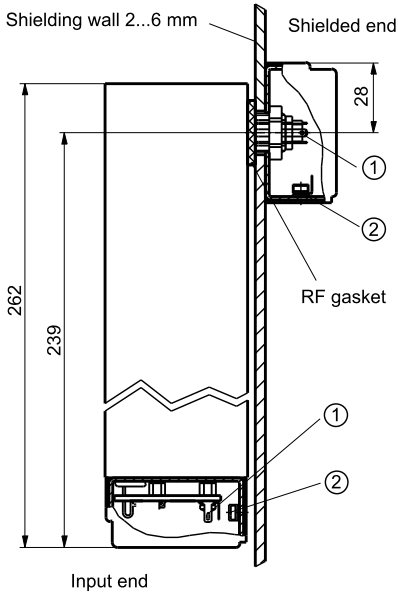
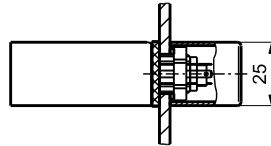
2-line filters, flat installation
Side view

Plan view

SGR0186-H-E

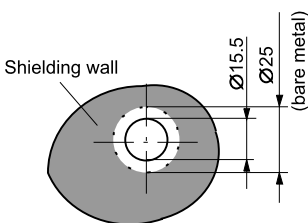
- ① Line connections at both ends:
2 x tab connectors for receptacle 2.8 x 0.5 (in accessory bag)
- ② Strain relief with ground connection for cable diameter 4.5 ... 6 mm

Hole for installation in shielding wall

SGR0185-9-E

20-line filters, upright installation

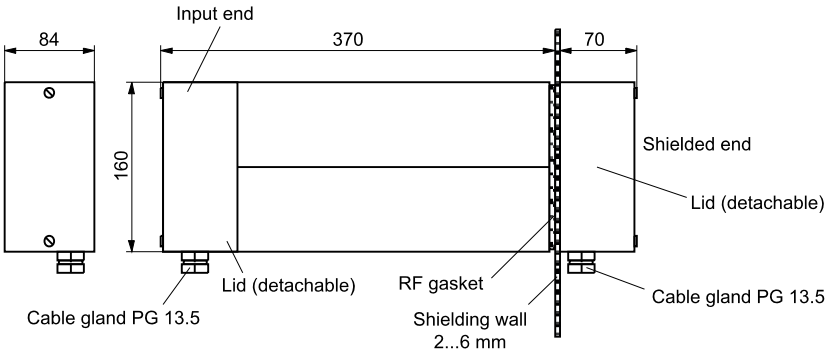

SGR0187-Q-E

Hole for installation in shielding wall

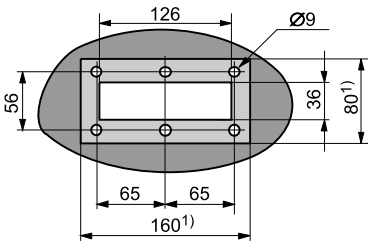

1) Bare metal

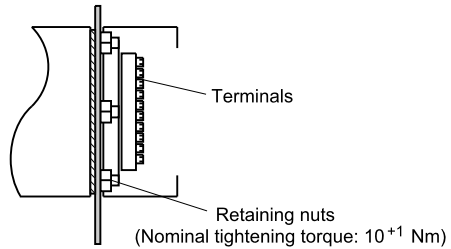

SGR0188-Y-E

Adapter

A bracket adapter is available for flat installation on the shielding wall.

Ordering code: B84298M0012C004

Bracket adapter B84298M0012C004

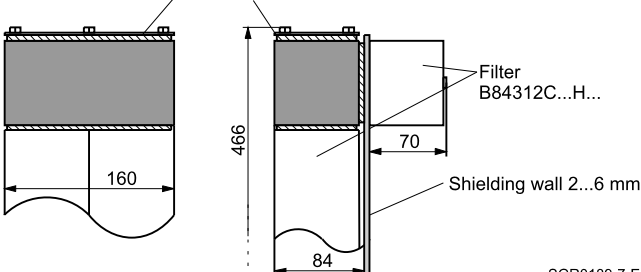

SGR0189-7-E