

DESCRIPTION

The MP2030 is a very low dropout, dual supply linear regulator. The use of two supplies allows the BIAS to control an NMOS device. The NMOS device supplies power to the load via the IN. In this way the input supply can be just above the desired output, yet still provide very good regulation performance due to the higher bias supply. The BIAS operates from a 2.5V to 5.5V input and regulates the output voltage to as low as 0.9V, and as high as 3.8V.

The MP2030 can supply up to 3A of load current with a typical dropout voltage of 150mV. The BIAS runs the internal reference and drive circuitry, while the output current comes directly from the IN for high efficiency regulation.

The low bias current of 220uA makes the MP2030 ideal for use in battery-powered applications. The BIAS can be directly applied from the battery while IN is powered from the high efficiency buck regulator. This will reduce the output noise and decoupling capacitor.

Other features of MP2030 include thermal overload and current limit protection, power good indicator, stability with ultra low ESR ceramic capacitors as low as 1uF, and fast transient response. The MP2030 is available in 10-pin QFN (3mm x 3mm), and in QFN (5mm x 5mm) packages.

FEATURES

- Wide 1.1V to 5.5V Input Voltage Range
- Stable with Very Small Ceramic Capacitors
- 150mV Dropout at 3A Output
- 2% Accurate Output Voltage
- Adjustable Output Range of 0.9V to 3.8V
- Low Noise: 80μV_{RMS} (10Hz to 100kHz)
- PSRR
 - 32dB at 100kHz
- Better Than 0.001%/mA Load Regulation
- Stable With Low-ESR Output Capacitors
- Low 220uA Ground Current
- Internal Thermal Protection
- Current Limit Protection
- 0.1μA Typical Quiescent Current at Shutdown
- Power Good Indicator

APPLICATIONS

- Network, Telecom, Equipment: Routers and Switches
- Servers, Storage Equipment
- Set-Top Box
- Post Regulation for Switch Mode
- Televisions

"MPS" and "The Future of Analog IC Technology" are Registered Trademarks of Monolithic Power Systems, Inc.

TYPICAL APPLICATION

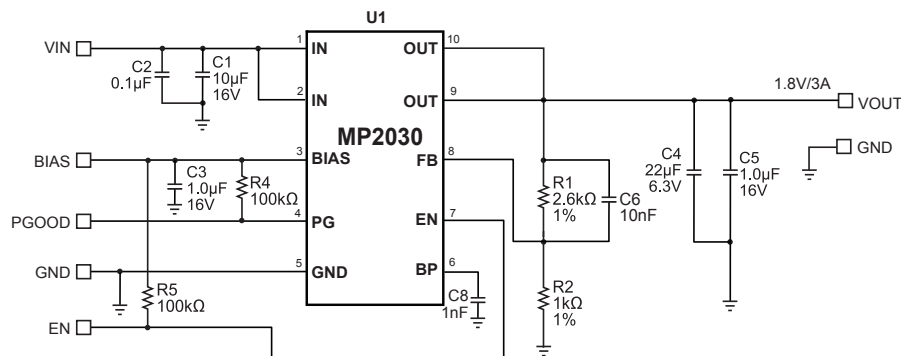

ORDERING INFORMATION

Part Number*	Package	Top Marking	Free Air Temperature (T _A)
MP2030DQ*	3x3 QFN10	7D	–40°C to +85°C
MP2030DU**	5x5 QFN32	M2030DU	–40°C to +85°C

* For Tape & Reel, add suffix –Z (eg. MP2030DQ–Z).
 For RoHS compliant packaging, add suffix –LF (eg. MP2030DQ–LF–Z)

** For Tape & Reel, add suffix –Z (eg. MP2030DU–Z).
 For RoHS compliant packaging, add suffix –LF (eg. MP2030DU–LF–Z)

PACKAGE REFERENCE

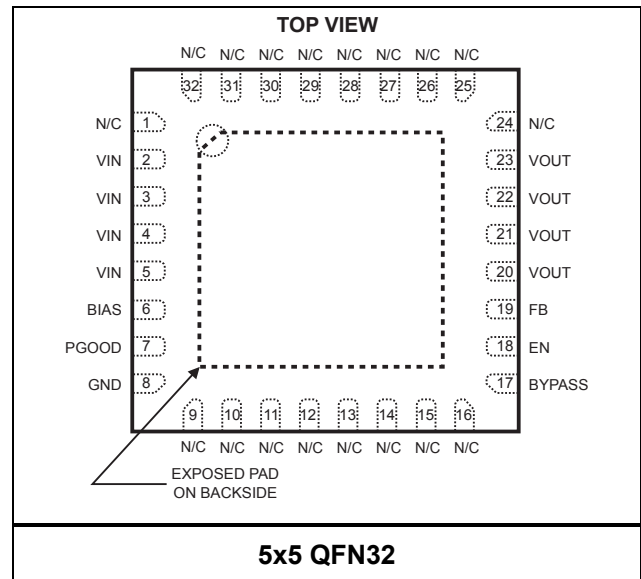
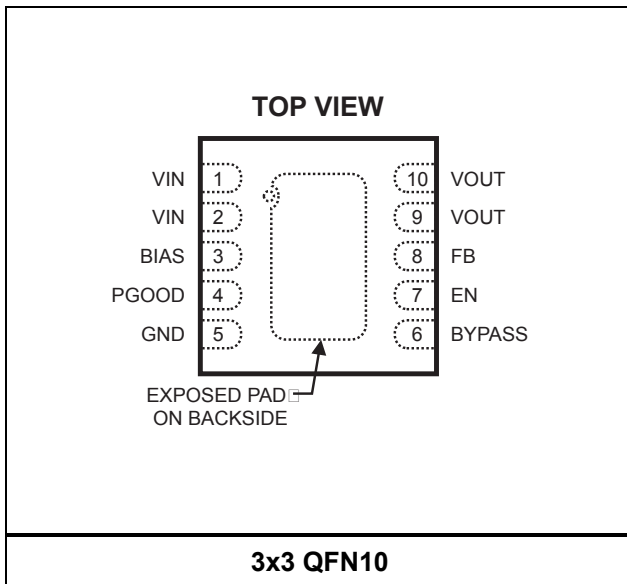

ABSOLUTE MAXIMUM RATINGS ⁽¹⁾

V _{BIAS} , V _{IN} to GND.....	–0.3V to +6V
FB, EN, to GND.....	–0.3V to 6V
V _{OUT}	–0.3V to V _{IN} + 0.3 or 6V
PGOOD.....	–0.3V to V _{BIAS} + 0.3 or 6V
BYPASS.....	–0.3V to V _{BIAS} + 0.3 or 6V
Junction Temperature.....	150°C
Lead Temperature.....	260°C
Storage Temperature.....	–65°C to +150°C

Power Dissipation

T _A =70°C (QFN10 3 x 3).....	1.3W
T _A =70°C (QFN32 5 x 5).....	1.8W

Recommended Operating Conditions ⁽²⁾

Input Voltage V _{IN}	1.1V to 5.5V
Input Voltage V _{BIAS}	2.5V to 5.5V
Output Voltage.....	0.9V to 3.6V
Load Current.....	3.0A Maximum
Operating Junct. Temp.	–40°C to +125°C

Thermal Resistance ⁽³⁾

	θ _{JA}	θ _{JC}
QFN10 3X3.....	50	12 °C/W
QFN32 5X5.....	36	8 °C/W

Notes:

- 1) Exceeding these ratings may damage the device.
- 2) The device is not guaranteed to function outside of its operating conditions.
- 3) Measured on JESD51-7, 4-layer PCB.

ELECTRICAL CHARACTERISTICS
 $V_{IN} = 1.5V$, $V_{BIAS} = 3.6V$, $V_{OUT} = 1.2V$, $C_{OUT} = 1\mu F$, $C_{IN} = 0.1\mu F$, $T_A = +25^\circ C$, unless otherwise noted.

Parameter	Symbol	Condition	Min	Typ	Max	Units
V_{IN} Operating Voltage			1.1		5.5	V
V_{BIAS} Operating Voltage			2.5		5.5	V
V_{BIAS} Operating Current				220		μA
FB Regulation Voltage			0.490	0.500	0.510	V
		$-40^\circ C \leq T_A \leq +85^\circ C$	0.485	0.500	0.515	
Dropout Voltage		$I_{OUT} = 3A$, $V_{BIAS} = 3.6V$		150		mV
V_{IN} Line Regulation		$I_{OUT} = 1mA$, $V_{IN} = 1.5$ to $5V$ $V_{BIAS} = 3.6V$ $V_{OUT} = 1.2V$		1		mV
V_{BIAS} Line Regulation		$I_{OUT} = 1mA$, $V_{BIAS} = 3.6V$ to $5.5V$ $V_{OUT} = 1.2V$ $V_{IN} = 1.5V$		2		mV
Load Regulation		$I_{OUT} = 1mA$ to $1A$		0.001		%/mA
PSRR (V_{IN})		$V_{IN} > V_{OUT} + 0.5V$, $C_{OUT} = 22\mu F$, $V_{IN(AC)} = 100mV$, $f = 100KHz$ $I_{OUT} = 300mA$		32		dB
Power Good Threshold				440		mV
Power Good Delay				160		μs
Soft Start		BYPASS=open		550		μs
Power Good Voltage		$I_{sink} = 230\mu A$		0.39		V
EN Input High Voltage			1.5			V
EN Input Low Voltage					0.8	V
EN Input Bias Current		$V_{EN} = 1.2V$	-1		+1	μA
Thermal Protection				135		$^\circ C$
Thermal Protection Hysteresis				15		$^\circ C$

PIN FUNCTIONS

QFN3X3 10pins

Pin #	Name	Description
9, 10	OUT	Regulator Output. OUT is the output of the linear regulator, By pass OUT to GND with a 4.7 μ F or greater capacitor.
3	BIAS	Bias Voltage. Bypass to ground with a 1 μ F or greater capacitor for maximum output current the $V_{IN} > 0.2V + V_{OUT}$ and $V_{BIAS} > 2V + V_{OUT}$.
8	FB	Feedback Input. Connect a resistive voltage divider from OUT to FB to set the output voltage. OUT feedback threshold is 0.5V.
7	EN	Enable Input. Drive EN high to turn on the MP2030, drive EN low to turn it off. For automatic startup, connect EN to IN.
5	GND	Ground, exposed pad.
1, 2	IN	Power Source Input. IN supplies power to the load at the output (through the power transistor). Bypass IN to GND with a 1 μ F or greater capacitor.
4	PGOOD	Open drain output. High indicated $V_{OUT} > 90\%$ final value.
6	BYPASS	Connect a 1nF to this pin. Do not load this pin resistively.

QFN5x5 32pins

Pin #	Name	Description
20, 21, 22, 23	VOUT	Regulator Output. OUT is the output of the linear regulator, By pass OUT to GND with a 4.7 μ F or greater capacitor.
6	BIAS	Bias Voltage. Bypass to ground with a 1 μ F or greater capacitor.
19	FB	Feedback Input. Connect a resistive voltage divider from OUT to FB to set the output voltage. OUT feedback threshold is 0.5V.
18	EN	Enable Input. Drive EN high to turn on the MP2030, drive EN low to turn it off. For automatic startup, connect EN to IN.
8	GND	Ground, exposed pad.
2, 3, 4, 5	VIN	Power Source Input. IN supplies power to the load at the output (through the power transistor). Bypass IN to GND with a 1 μ F or greater capacitor.
7	PGOOD	Open drain output. High indicated $V_{OUT} > 90\%$ final value.
17	BYPASS	Connect a 1nF to this pin. Do not load this pin resistively.
1, 9, 10, 11, 12, 13, 14, 15, 16, 24, 25, 26, 27, 28, 29, 30, 31, 32	NC	These are no connection pins.

TYPICAL PERFORMANCE CHARACTERISTICS

C1=10μF, C2=0.1μF, C3=1.0μF, C4=22μF, C6=22nF, V_B=5.5V, T_A=25°C, unless otherwise noted

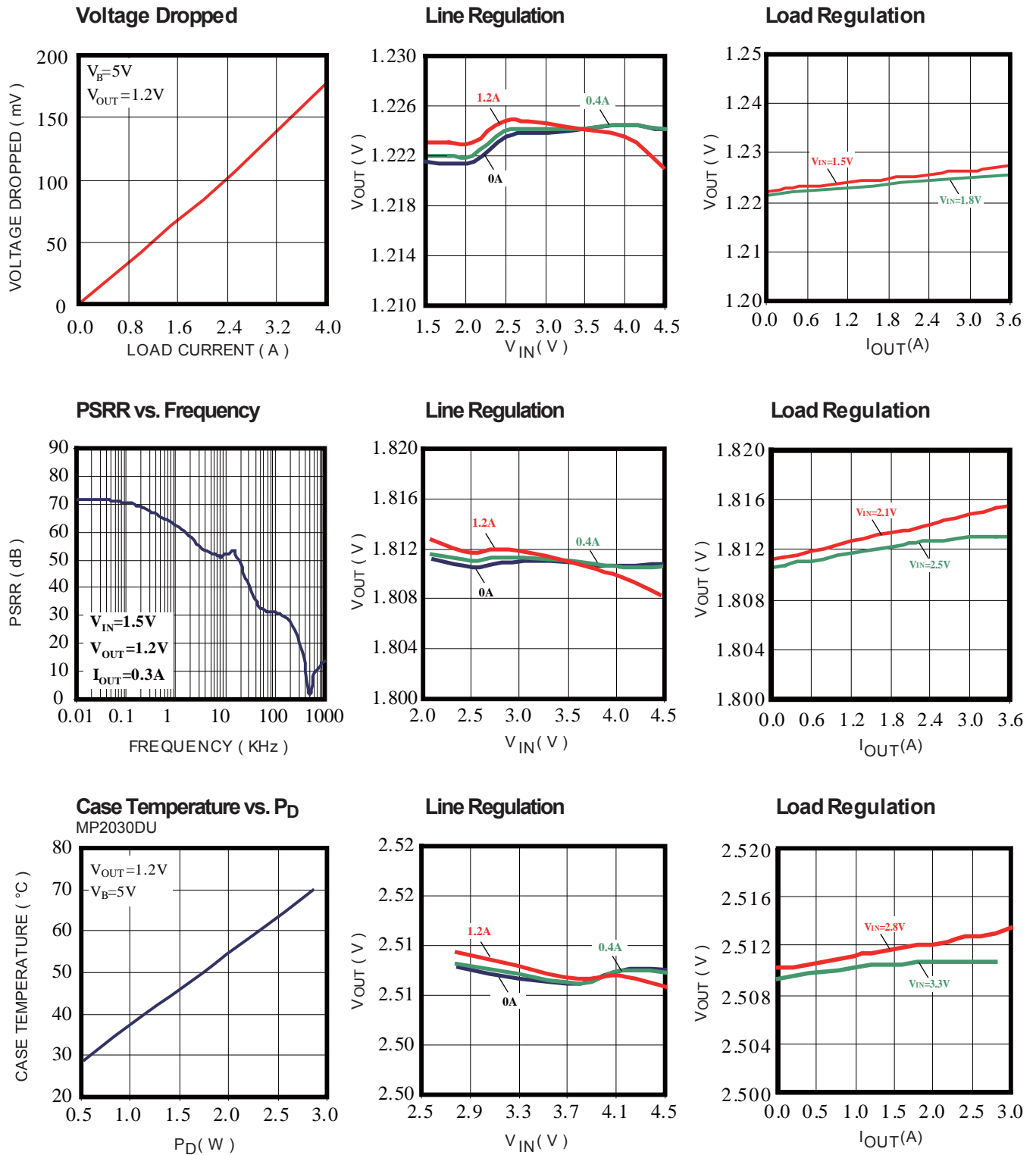

TYPICAL PERFORMANCE CHARACTERISTICS

C1=10µF, C2=0.1µF, C3=1.0µF, C4=22µF, C6=22nF, V_B=5.5V, T_A=25°C, unless otherwise noted

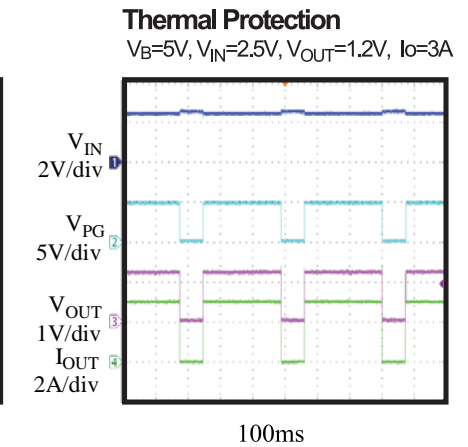
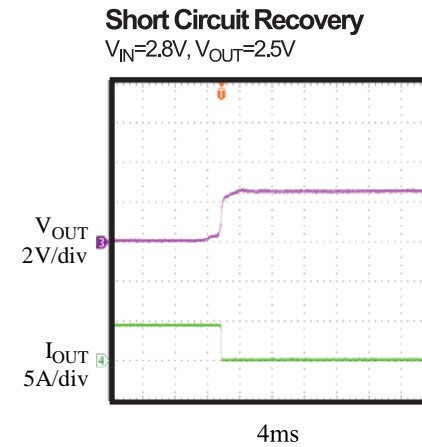
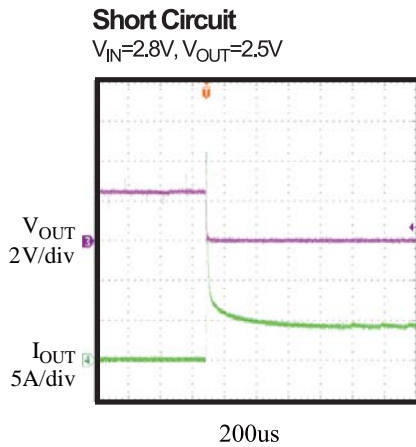
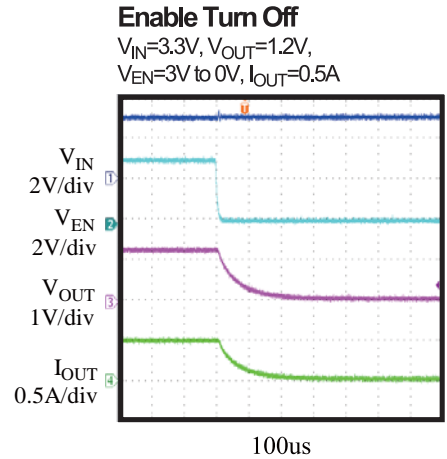
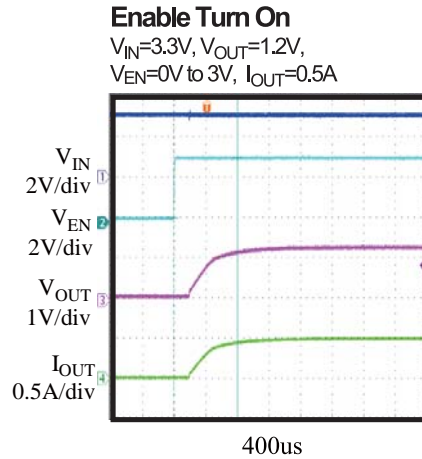
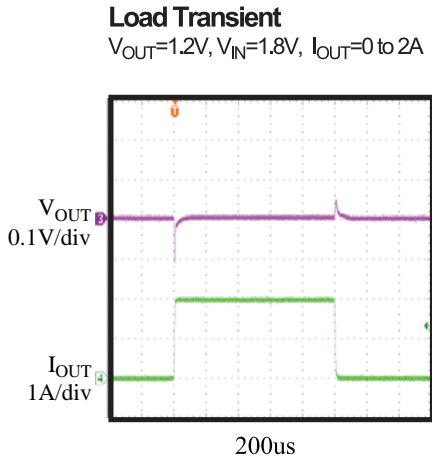
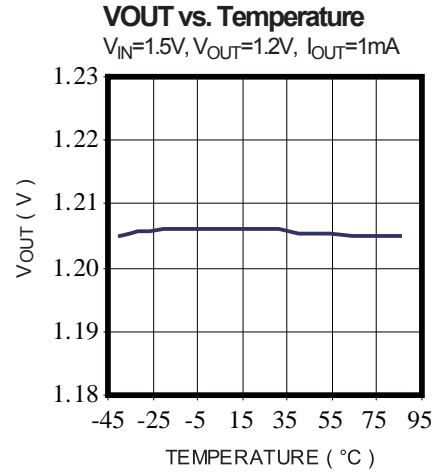
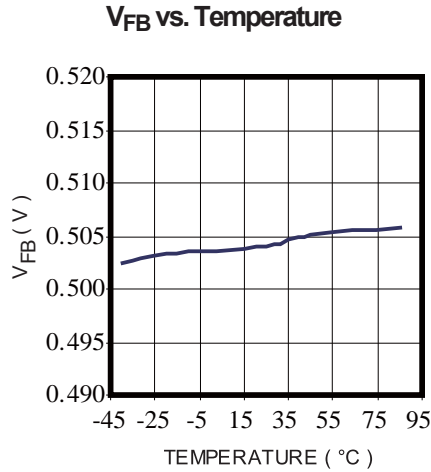
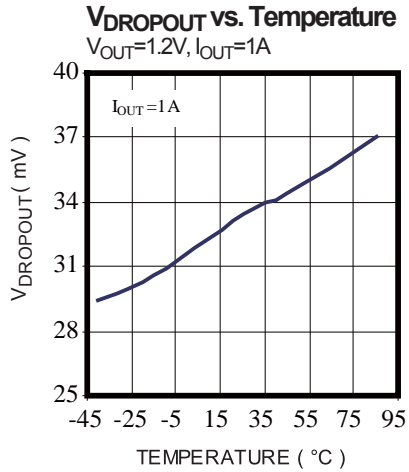

TYPICAL PERFORMANCE CHARACTERISTICS

C1=10μF, C2=0.1μF, C3=1.0μF, C4=22μF, C6=22nF, V_B=5.5V, T_A=25°C, unless otherwise noted

Power Rump Up

V_{IN}=2.1V, V_{OUT}=1.8V, I_{OUT}=3A, with Resistor load

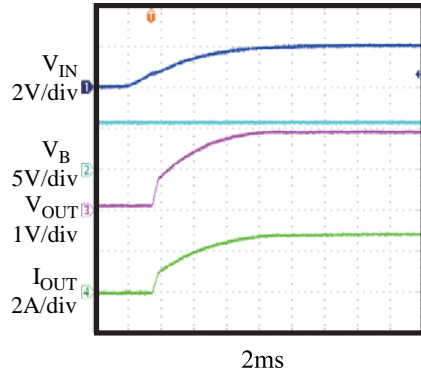

Power Rump Down

V_{IN}=2.1V, V_{OUT}=1.8V, I_{OUT}=3A, with Resistor load

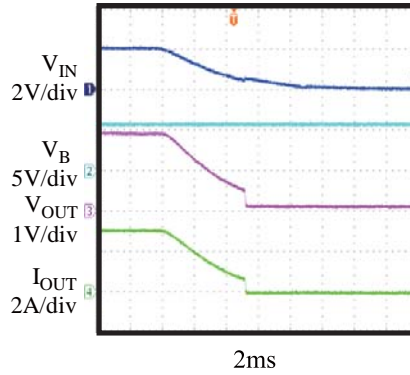

Line Transient

V_{IN}=1.8 to 5V, V_{OUT}=1.2V, I_{OUT}=0.2A,

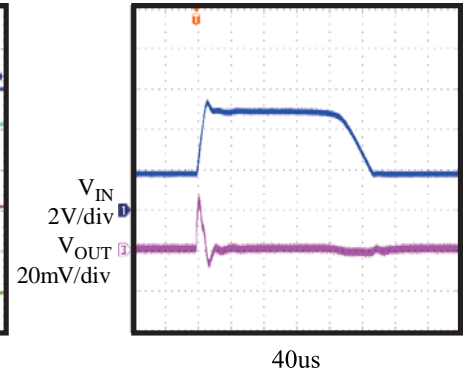

BLOCK DIAGRAM

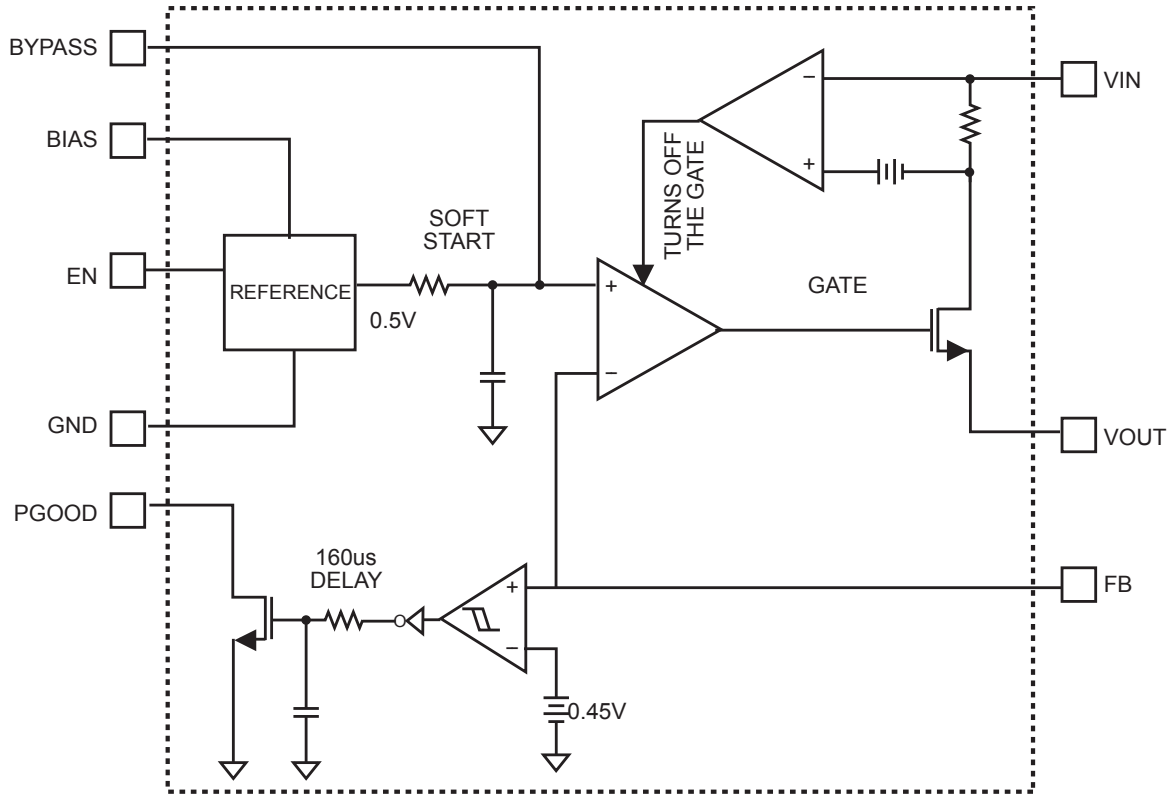

Figure 1—Block Diagram of Low Dropout Regulator

OPERATION

MP2030 Theory of Operation

The MP2030 linear dropout regulator provides adjustable output voltages from 0.9V to 3.6V at currents up to 3A. This LDO is protected against short circuits, and it has thermal shut down protection with 15°C hysteresis.

Utilizing Two Power Supplies

In order to maximize the efficiency MP2030 uses two power supplies. One power supply is connected to the BIAS pin and it is used to power up the internal circuitries including band gap reference and the rest of control circuitries. The other power supply is connected to the VIN pins which are the drain of pass device. This power supply can be set close to output voltage of LDO. The output pins are the source of the pass device. The smaller voltage drop across the pass device translates to the smaller power loss in pass device. Thus, the part operates with higher efficiency.

Internal Current Limit

The MP2030 has an internal current limit set at almost 4.5A. When the output current is greater than 4.5A, current limit is activated, the output voltage is internally forced close to ground, and stays at this voltage until the short circuit is removed. Internal current limit is very well controlled over process variations and ambient temperature.

Enable

The enable (EN) pin is active high. The enable pin has a built-in hysteresis. If this pin is held below 0.8V then part shuts down and draws less than 1uA from V_{BIAS} supply.

If not used then connect this pin to V_{BIAS} .

Under Voltage Lockout

The Bias voltage is monitored by a circuit that prevents the LDO start up when the bias voltage is below 2.35V. This circuitry has an approximate hysteresis of 90mV.

Soft Start

MP2030 incorporates internal soft start function. This internal function reduces the start up current surge into the output capacitor. This allows the gradual built up of output voltage to its final set value. The internal soft start cap is held to ground if there is a fault condition. The fault conditions are UVLO, Thermal shut down, and disable. The internal soft start time is almost 550us.

Power Good

The Power Good pin is an open drain output and can be connected to Bias voltage via a pull up resistor. Open drain transistor turns off and PG pin voltage value becomes V_{BIAS} when V_{FB} exceeds 450mV. Also PG pin can sink at least 230μA while being low.

Setting the Output Voltage

The MP2030 has an adjustable output voltage, set by using a resistive voltage divider from the output voltage to FB pin. The voltage divider divides the output voltage down to the feedback voltage by the ratio:

$$V_{FB} = V_{OUT} * R_2 / (R_1 + R_2)$$

Where V_{FB} is the feedback threshold voltage ($V_{FB}=0.5V$), and V_{OUT} is the output voltage. R_1 connects between V_{OUT} and V_{FB} , and R_2 connects between V_{FB} and ground.

Thus the output voltage is:

$$V_{OUT} = 0.5 * (R_1 + R_2) / R_2$$

R_2 can be as high as 100KΩ, but a typical value is 10KΩ. Using that value, R_1 is determined by:

$$R_1 = R_2 * (V_{OUT} - V_{FB}) / V_{FB}$$

For example, for a 1.8V output voltage, R_2 is 10KΩ, and R_1 is 26kΩ. You can select 26kΩ (1%) resistor for R_1 .

Power Dissipation

Most of the power dissipation is due to power dissipation in PASS device. For example, assume $V_{BIAS}=5.0V$, $V_{IN}=2.0V$, $V_{OUT}=1.8V$, and $I_{OUT}=3A$:

$$P_D (PASS) = (V_{IN} - V_{OUT}) * I_{OUT}$$

$$P_D (PASS) = (2.0V - 1.8V) * 3A = 0.6$$

$P_{BIAS} = V_{BIAS} \times I_{GND} = 5V \times (220\mu A) = 1.25mW$.
This is negligible compared to $P_D (PASS) = 0.6W$

For QFN 3X3 θ_{JA} is $50^{\circ}C/W$.

0.6W power is dissipated when 3A output current goes through PASS device with $V_{IN}=2.0V$, and $V_{OUT}=1.8V$.

This gives a rise in die temperature for $0.6 \times 50^{\circ}C/W=30^{\circ}C$

This is a safe operating point assuming a junction temperature of $135^{\circ}C$ at an $85^{\circ}C$ ambient temperature.

A heat sink needs to be utilized for a better temperature performance.

PACKAGE INFORMATION

QFN10 (3mm x 3mm)

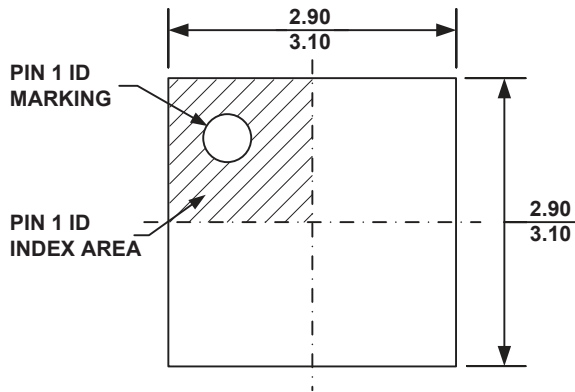

TOP VIEW

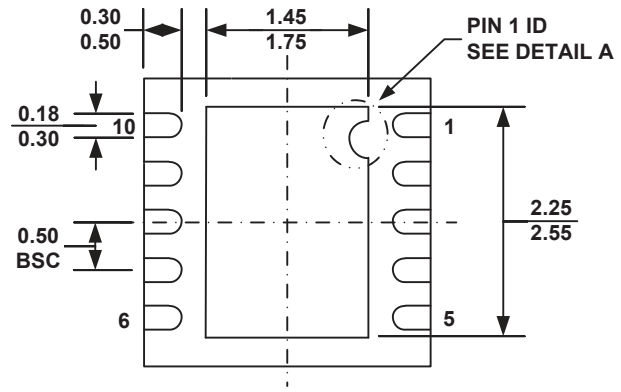

BOTTOM VIEW

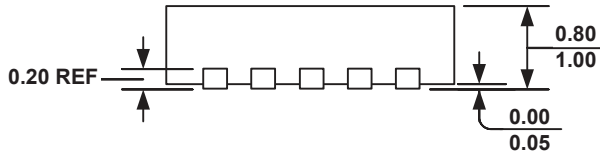

SIDE VIEW

**PIN 1 ID OPTION A
R0.20 TYP.**

**PIN 1 ID OPTION B
R0.20 TYP.**



DETAIL A

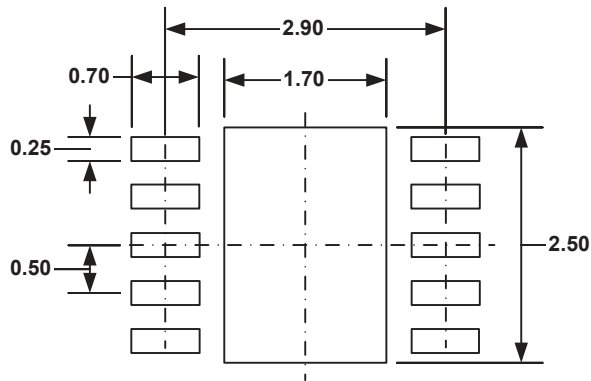

RECOMMENDED LAND PATTERN

NOTE:

- 1) ALL DIMENSIONS ARE IN MILLIMETERS.
- 2) EXPOSED PADDLE SIZE DOES NOT INCLUDE MOLD FLASH.
- 3) LEAD COPLANARITY SHALL BE 0.10 MILLIMETER MAX.
- 4) DRAWING CONFORMS TO JEDEC MO-229, VARIATION VEED-5.
- 5) DRAWING IS NOT TO SCALE.

QFN32 (5mm x 5mm)

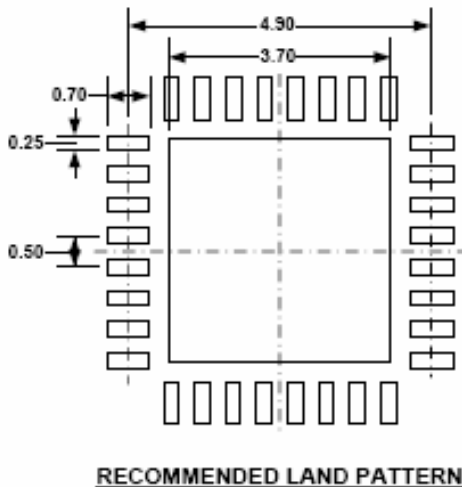
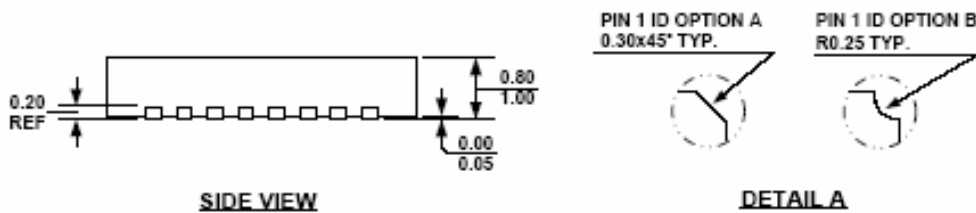
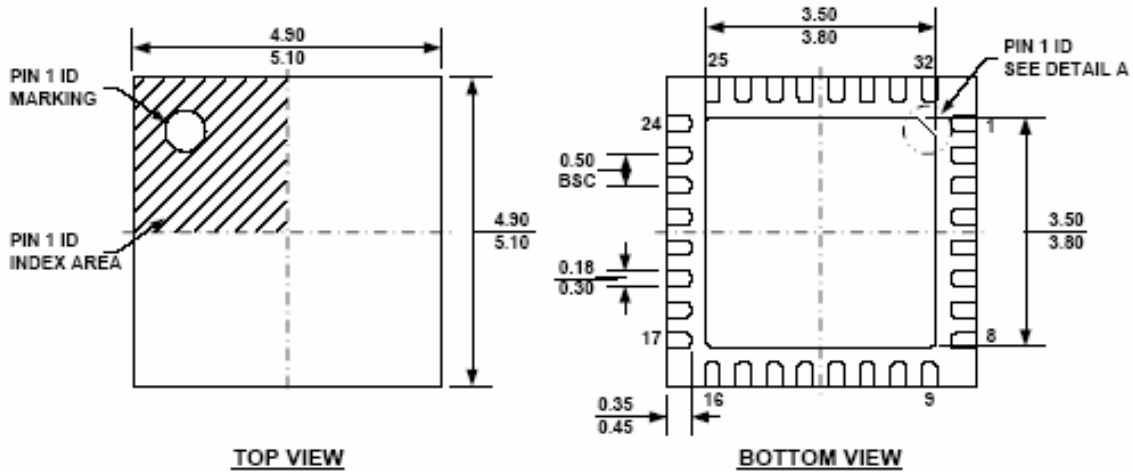

NOTE:

- 1) ALL DIMENSIONS ARE IN MILLIMETERS.
- 2) EXPOSED PADDLE SIZE DOES NOT INCLUDE MOLD FLASH.
- 3) LEAD COPLANARITY SHALL BE 0.10 MILLIMETER MAX.
- 4) DRAWING CONFIRMS TO JEDEC MO-220, VARIATION VHHC-2.
- 5) DRAWING IS NOT TO SCALE.

NOTICE: The information in this document is subject to change without notice. Please contact MPS for current specifications. Users should warrant and guarantee that third party Intellectual Property rights are not infringed upon when integrating MPS products into any application. MPS will not assume any legal responsibility for any said applications.