

Notice for TAIYO YUDEN products

Please read this notice before using the TAIYO YUDEN products.

REMINDERS

- Product information in this catalog is as of October 2012. All of the contents specified herein are subject to change without notice due to technical improvements, etc. Therefore, please check for the latest information carefully before practical application or usage of the Products.

Please note that Taiyo Yuden Co., Ltd. shall not be responsible for any defects in products or equipment incorporating such products, which are caused under the conditions other than those specified in this catalog or individual specification.

- Please contact Taiyo Yuden Co., Ltd. for further details of product specifications as the individual specification is available.
- Please conduct validation and verification of products in actual condition of mounting and operating environment before commercial shipment of the equipment.
- All electronic components or functional modules listed in this catalog are developed, designed and intended for use in general electronics equipment.(for AV, office automation, household, office supply, information service, telecommunications, (such as mobile phone or PC) etc.). Before incorporating the components or devices into any equipment in the field such as transportation,(automotive control, train control, ship control), transportation signal, disaster prevention, medical, public information network (telephone exchange, base station) etc. which may have direct influence to harm or injure a human body, please contact Taiyo Yuden Co., Ltd. for more detail in advance. Do not incorporate the products into any equipment in fields such as aerospace, aviation, nuclear control, submarine system, military, etc. where higher safety and reliability are especially required.

In addition, even electronic components or functional modules that are used for the general electronic equipment, if the equipment or the electric circuit require high safety or reliability function or performances, a sufficient reliability evaluation check for safety shall be performed before commercial shipment and moreover, due consideration to install a protective circuit is strongly recommended at customer's design stage.

- The contents of this catalog are applicable to the products which are purchased from our sales offices or distributors (so called "TAIYO YUDEN' s official sales channel").
It is only applicable to the products purchased from any of TAIYO YUDEN' s official sales channel.
- Please note that Taiyo Yuden Co., Ltd. shall have no responsibility for any controversies or disputes that may occur in connection with a third party's intellectual property rights and other related rights arising from your usage of products in this catalog. Taiyo Yuden Co., Ltd. grants no license for such rights.

■ Caution for export

Certain items in this catalog may require specific procedures for export according to "Foreign Exchange and Foreign Trade Control Law" of Japan, "U.S. Export Administration Regulations", and other applicable regulations. Should you have any question or inquiry on this matter, please contact our sales staff.

WIRE-WOUND CHIP INDUCTORS FOR SIGNAL LINES (LB SERIES M TYPE)



REFLOW

PARTS NUMBER

L	B	M	2	0	1	6	T	1	0	0	J	△
①			②				③				⑤	⑥

△=Blank space

① Series name

Code	Series name
LBM	Wound chip inductor for signal line

② Dimensions (L × W)

Code	Dimensions (L × W) [mm]
2016	2.0 × 1.6

③ Packaging

Code	Packaging
T	Taping

④ Nominal inductance

Code (example)	Nominal inductance [μH]
R12	0.12
1R0	1.00
100	10
101	100

※R=Decimal point

⑤ Inductance tolerance

Code	Inductance tolerance
J	±5%

⑥ Internal code

STANDARD EXTERNAL DIMENSIONS / STANDARD QUANTITY

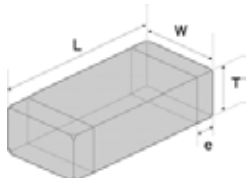

Recommended Land Patterns

Surface Mounting

- Mounting and soldering conditions should be checked beforehand.
- Applicable soldering process to these products is reflow soldering only.

Type	A	B	C
LBM2016	0.6	1.0	1.8

Unit: mm

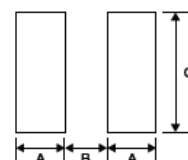

Type	L	W	T	e	Standard quantity [pcs]	
					Paper tape	Embossed tape
LBM2016	2.0±0.2 (0.08±0.008)	1.6±0.2 (0.063±0.008)	1.6±0.2 (0.063±0.008)	0.5±0.2 (0.02±0.008)	—	2000

Unit: mm (inch)

PARTS NUMBER

LBM2016 type

Parts number	EHS	Nominal inductance [μH]	Inductance tolerance	Q (min.)	Self-resonant frequency [MHz] (min.)	DC Resistance [Ω] (±30%)	Rated current [mA] (max.)	Measuring frequency [MHz]
LBM 2016TR12J	RoHS	0.12	±5%	30	600	0.13	610	25.2
LBM 2016TR15J	RoHS	0.15	±5%	30	550	0.15	570	25.2
LBM 2016TR18J	RoHS	0.18	±5%	30	500	0.15	560	25.2
LBM 2016TR22J	RoHS	0.22	±5%	30	450	0.20	520	25.2
LBM 2016TR27J	RoHS	0.27	±5%	30	425	0.21	510	25.2
LBM 2016TR33J	RoHS	0.33	±5%	30	400	0.21	490	25.2
LBM 2016TR39J	RoHS	0.39	±5%	30	375	0.26	440	25.2
LBM 2016TR47J	RoHS	0.47	±5%	30	350	0.26	430	25.2
LBM 2016TR56J	RoHS	0.56	±5%	30	300	0.29	410	25.2
LBM 2016TR68J	RoHS	0.68	±5%	30	270	0.32	400	25.2
LBM 2016TR82J	RoHS	0.82	±5%	30	250	0.34	390	25.2
LBM 2016T1R0J	RoHS	1.0	±5%	30	220	0.38	385	7.96
LBM 2016T1R2J	RoHS	1.2	±5%	30	180	0.41	370	7.96
LBM 2016T1R5J	RoHS	1.5	±5%	30	135	0.47	350	7.96
LBM 2016T1R8J	RoHS	1.8	±5%	30	100	0.48	345	7.96
LBM 2016T2R2J	RoHS	2.2	±5%	30	75	0.54	340	7.96
LBM 2016T2R7J	RoHS	2.7	±5%	30	55	0.59	310	7.96
LBM 2016T3R3J	RoHS	3.3	±5%	30	48	0.68	290	7.96
LBM 2016T3R9J	RoHS	3.9	±5%	30	43	0.74	275	7.96
LBM 2016T4R7J	RoHS	4.7	±5%	30	40	0.78	270	7.96
LBM 2016T5R6J	RoHS	5.6	±5%	25	36	0.88	255	7.96
LBM 2016T6R8J	RoHS	6.8	±5%	25	33	0.97	240	7.96
LBM 2016T8R2J	RoHS	8.2	±5%	25	30	1.1	225	7.96
LBM 2016T100J	RoHS	10	±5%	25	27	1.2	215	2.52
LBM 2016T120J	RoHS	12	±5%	25	23	1.4	200	2.52
LBM 2016T150J	RoHS	15	±5%	25	20	1.5	190	2.52
LBM 2016T180J	RoHS	18	±5%	25	18	2.5	150	2.52
LBM 2016T220J	RoHS	22	±5%	25	17	2.8	140	2.52
LBM 2016T270J	RoHS	27	±5%	25	16	3.2	130	2.52
LBM 2016T330J	RoHS	33	±5%	25	15	3.6	125	2.52
LBM 2016T390J	RoHS	39	±5%	20	14	3.9	120	2.52
LBM 2016T470J	RoHS	47	±5%	20	13	4.1	115	2.52
LBM 2016T560J	RoHS	56	±5%	20	12	5.9	95	2.52
LBM 2016T680J	RoHS	68	±5%	20	11	7.0	90	2.52
LBM 2016T820J	RoHS	82	±5%	20	10	7.7	85	2.52
LBM 2016T101J	RoHS	100	±5%	15	9.0	8.0	80	0.796

▶ This catalog contains the typical specification only due to the limitation of space. When you consider the purchase of our products, please check our specification. For details of each product (characteristics graph, reliability information, precautions for use, and so on), see our Web site (<http://www.ty-top.com/>).

WIRE-WOUND CHIP INDUCTORS (LB SERIES), WIRE-WOUND CHIP POWER INDUCTORS (CB SERIES), WIRE-WOUND CHIP INDUCTORS FOR SIGNAL LINES (LB SERIES M TYPE)

PACKAGING

① Minimum Quantity

Type	Standard Quantity [pcs]	
	Paper Tape	Embossed Tape
LB C3225	—	1000
CB C3225	—	—
LB 3218	—	2000
LB R2518	—	—
LB C2518	—	—
LB 2518	—	2000
CB 2518	—	—
CB C2518	—	—
LBM2016	—	—
LB C2016	—	—
LB 2016	—	2000
CB 2016	—	—
CB C2016	—	—
LB 2012	—	—
LB C2012	—	—
LB R2012	—	3000
CB 2012	—	—
CB C2012	—	—
CB L2012	4000	—
LB 1608	4000	—
LBMF1608	—	3000
CBMF1608	—	—

② Tape material

- Embossed tape

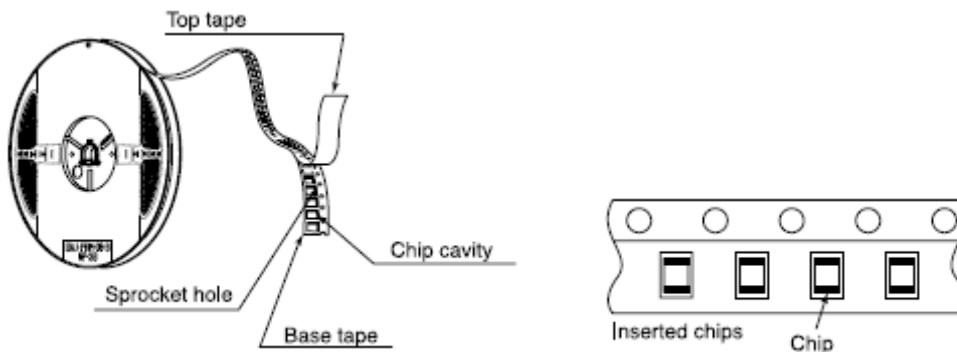

③ Taping Dimensions

- Embossed Tape (0.315 inches wide)
- Card board carrier tape (0.315 inches wide)

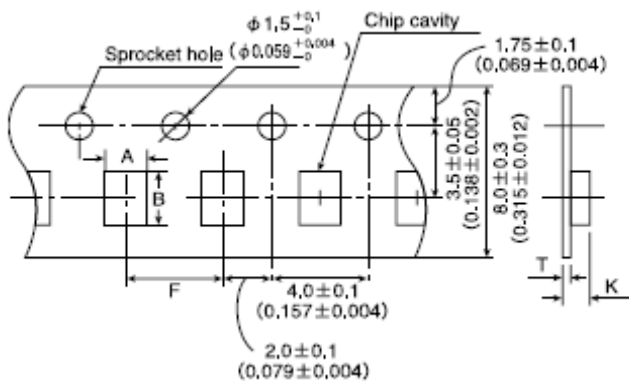

▶ This catalog contains the typical specification only due to the limitation of space. When you consider the purchase of our products, please check our specification. For details of each product (characteristics graph, reliability information, precautions for use, and so on), see our Web site (<http://www.ty-top.com/>).

Type	Chip cavity		Insertion pitch	Tape thickness	
	A	B		T	K
LBM2016	1.75±0.1 (0.069±0.004)	2.1±0.1 (0.083±0.004)	4.0±0.1 (0.157±0.004)	0.3±0.05 (0.012±0.002)	1.9max. (0.075max.)
LB C3225 CB C3225	2.8±0.1 (0.110±0.004)	3.5±0.1 (0.138±0.004)	4.0±0.1 (0.157±0.004)	0.3±0.05 (0.012±0.002)	4.0max. (0.157max.)
LB 3218	2.1±0.1 (0.083±0.004)	3.5±0.1 (0.138±0.004)	4.0±0.1 (0.157±0.004)	0.3±0.05 (0.012±0.002)	2.2max. (0.087max.)
LB 2518 CB 2518 LB C2518 CB C2518 LB R2518	2.15±0.1 (0.085±0.004)	2.7±0.1 (0.106±0.004)	4.0±0.1 (0.157±0.004)	0.3±0.05 (0.012±0.002)	2.2max. (0.087max.)
LB 2016 CB 2016 LB C2016 CB C2016	1.75±0.1 (0.069±0.004)	2.1±0.1 (0.083±0.004)	4.0±0.1 (0.157±0.004)	0.3±0.05 (0.012±0.002)	1.9max. (0.075max.)
LB 2012 CB 2012 LB C2012 CB C2012 LB R2012	1.45±0.1 (0.057±0.004)	2.25±0.1 (0.089±0.004)	4.0±0.1 (0.157±0.004)	0.25±0.05 (0.010±0.002)	1.45max. (0.057max.)
CB L2012	1.55±0.1 (0.061±0.004)	2.3±0.1 (0.091±0.004)	4.0±0.1 (0.157±0.004)	1.1max. (0.043max.)	1.1max. (0.043max.)
LB 1608	1.0±0.1 (0.039±0.004)	1.8±0.1 (0.071±0.004)	4.0±0.1 (0.157±0.004)	1.1max. (0.043max.)	1.1max. (0.043max.)
LBMF1608 CBMF1608	1.1±0.1 (0.043±0.004)	1.9±0.1 (0.075±0.004)	4.0±0.1 (0.157±0.004)	0.25±0.05 (0.010±0.002)	1.2max. (0.047max.)

Unit: mm (inch)

④ Leader and Blank Portion

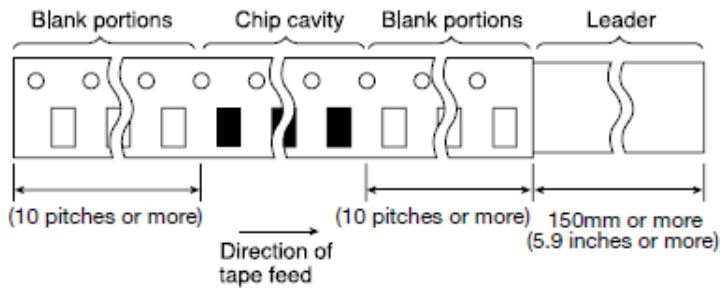

⑤ Reel Size

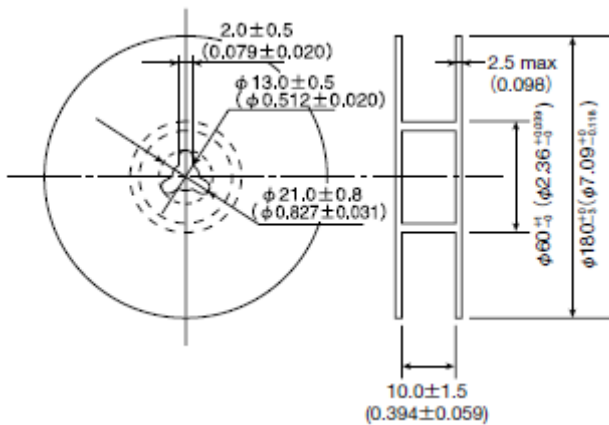

⑥ Top Tape Strength

The top tape requires a peel-off force 0.2 to 0.7N in the direction of the arrow as illustrated below.

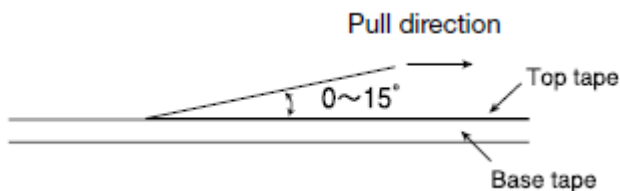

▶ This catalog contains the typical specification only due to the limitation of space. When you consider the purchase of our products, please check our specification. For details of each product (characteristics graph, reliability information, precautions for use, and so on), see our Web site (<http://www.ty-top.com/>).

WIRE-WOUND CHIP INDUCTORS (LB SERIES), WIRE-WOUND CHIP POWER INDUCTORS (CB SERIES), WIRE-WOUND CHIP INDUCTORS FOR SIGNAL LINES (LB SERIES M TYPE)

RELIABILITY DATA

1. Operating temperature Range		
Specified Value	LB, LBC, LBR, LBMF Series	-40~ +105°C (Including self-generated heat)
	CB, CBC, CBL, CBMF Series	
	LBM Series	
2. Storage Temperature Range (after soldering)		
Specified Value	LB, LBC, LBR, LBMF Series	-40~ +85°C
	CB, CBC, CBL, CBMF Series	
	LBM Series	
Test Methods and Remarks	LB, CB Series : Please refer the term of "7. storage conditions" in precautions.	
3. Rated Current		
Specified Value	LB, LBC, LBR, LBMF Series	Within the specified tolerance
	CB, CBC, CBL, CBMF Series	
	LBM Series	
4. Inductance		
Specified Value	LB, LBC, LBR, LBMF Series	Within the specified tolerance
	CB, CBC, CBL, CBMF Series	
	LBM Series	
Test Methods and Remarks	LB・LBC・LBR・CB・CBC・CBL・LBMF・CBMF・LBM Series Measuring equipmet : LCR Mater (HP4285A or its equivalent)	
5. Q		
Specified Value	LB, LBC, LBR, LBMF Series	-
	CB, CBC, CBL, CBMF Series	
	LBM Series	Within the specified tolerance
Test Methods and Remarks	LBM Series Measuring equipment : LCR Mater (HP4285A or its equivalent)	
6. DC Resitance		
Specified Value	LB, LBC, LBR, LBMF Series	Within the specified tolerance
	CB, CBC, CBL, CBMF Series	
	LBM Series	
Test Methods and Remarks	Measuring equipment : DC Ohmmeter (HIOKI 3227 or its equivalent)	
7. Self-Resonant Frequency		
Specified Value	LB, LBC, LBR, LBMF Series	Within the specified tolerance
	CB, CBC, CBL, CBMF Series	
	LBM Series	
Test Methods and Remarks	Measuring equipment : Impedance analyzer (HP4291A or its equivalent)	

▶ This catalog contains the typical specification only due to the limitation of space. When you consider the purchase of our products, please check our specification.
For details of each product (characteristics graph, reliability information, precautions for use, and so on), see our Web site (<http://www.ty-top.com/>).

8. Temperature Characteristic					
Specified Value	LBM2016				Inductance change : Within $\pm 5\%$
	LB1608	LB2012	LBR2012	CB2012	Inductance change : Within $\pm 20\%$
	CBL2012	LB2016	CB2016	LB2518	
	LBR2518	CB2518	LBC3225	CBC3225	
	LBMF1608	CBMF1608	LBC2016	CBC2016	Inductance change : Within $\pm 25\%$
LBC2518	CBC2518	LB3218			
Test Methods and Remarks	LBC2012				Inductance change : Within $\pm 35\%$
	CBC2012				
Test Methods and Remarks	Change of maximum inductance deviation in step 1-5				
	Step	Temperature (°C)			
		LB, CB Series			
	1	20			
	2	-40			
	3	20 (Reference temperature)			
	4	+85 (Maximum operating temperature)			
5	20				

9. Resistance to Flexure of Substrate			
Specified Value	LB, LBC, LBR, LBMF Series		No damage.
	CB, CBC, CBL, CBMF Series		
	LBM Series		
Test Methods and Remarks	Warp : 2mm (LB·LBC·LBR·CB·CBC·CBL·LBM·LBMF·CBMF Series)		
	Test substrate : Board according to JIS C0051 Thickness : 0.8mm (LB·LBMF·CBMF1608) : 1.0mm (Others)		

10. Body Strength			
Specified Value	LB, LBC, LBR, LBMF Series		No damage.
	CB, CBC, CBL, CBMF Series		
	LBM Series		
Test Methods and Remarks	LB·LBC·LBR·CB·CBC·CBL·LBM		
	Applied force : 10N Duration : 10sec. LB1608·LBMF1608·CBMF1608 Applied force : 5N Duration : 10sec.		

11. Adhesion of terminal electrode			
Specified Value	LB, LBC, LBR, LBMF Series		No abnormality.
	CB, CBC, CBL, CBMF Series		
	LBM Series		
Test Methods and Remarks	LB·LBC·LBR·CB·CBC·CBL·LBM·LBMF·CBMF		
	Applied force : 10N to X and Y directions Duration : 5 sec. Test substrate : Printed board LB1608·CBMF1608·LBMF1608 Applied force : 5N to X and Y directions Duration : 5 sec. Test substrate : Printed board		

▶ This catalog contains the typical specification only due to the limitation of space. When you consider the purchase of our products, please check our specification. For details of each product (characteristics graph, reliability information, precautions for use, and so on), see our Web site (<http://www.ty-top.com/>).

12. Resistance to vibration		
Specified Value	LB, LBC, LBR, LBMF Series	Inductance change : Within $\pm 10\%$ No significant abnormality in appearance.
	CB, CBC, CBL, CBMF Series	
	LBM Series	Inductance change : Within $\pm 5\%$ No significant abnormality in appearance.
Test Methods and Remarks	LB•LBR•LBC•CB•CBC•CBL•LBM•LBMF•CBMF : According to JIS C5102 clause 8.2. Vibration type : A Directions : 2 hrs each in X, Y and Z directions. Total: 6 hrs Frequency range : 10 to 55 to 10 Hz (1min.) Amplitude : 1.5mm Mounting method : Soldering onto printed board Recovery : At least 2 hrs of recovery under the standard condition after the test, followed by the measurement within 48 hrs.	

13. Drop test		
Specified Value	LB, LBC, LBR, LBMF Series	—
	CB, CBC, CBL, CBMF Series	
	LBM Series	

14. Solderability		
Specified Value	LB, LBC, LBR, LBMF Series	At least 90% of surface of terminal electrode is covered by new
	CB, CBC, CBL, CBMF Series	
	LBM Series	
Test Methods and Remarks	LB•LBC•LBR•CB•CBC•CBL•LBM•LBMF•CBMF : Solder temperature : $245 \pm 5^\circ\text{C}$ Duration : $5 \pm 0.5\text{sec}$ Flux : Methanol solution with 25% of colophony	

15. Resistance to soldering		
Specified Value	LB, LBC, LBR, LBMF Series	Inductance change : Within $\pm 10\%$
	CB, CBC, CBL, CBMF Series	
	LBM Series	Inductance change : Within $\pm 5\%$
Test Methods and Remarks	LB•LBC•LBR•CB•CBC•CBL•LBM•LBMF•CBMF : 3 times of reflow oven at 230°C MIN for 40sec. with peak temperature at 260°C for 5sec.	

16. Resistance to solvent		
Specified Value	LB, LBC, LBR, LBMF Series	No significant abnormality in appearance
	CB, CBC, CBL, CBMF Series	
	LBM Series	
Test Methods and Remarks	Solvent temperature : Room temperature Type of solvent : Isopropyl alcohol Cleaning conditions : 90s. Immersion and cleaning.	

17. Thermal shock		
Specified Value	LB, LBC, LBR, LBMF Series	Inductance change : Within $\pm 10\%$ No significant abnormality in appearance.
	CB, CBC, CBL, CBMF Series	
	LBM Series	
Test Methods and Remarks	LB•LBC•LBR•CB•CBC•CBL•LBM•LBMF•CBMF : $-40 \sim +85^\circ\text{C}$, maintain times 30min. ,100 cycle Recovery : At least 2 hrs of recovery under the standard condition after the test, followed by the measurement within 48 hrs.	

18.Damp heat life test		
Specified Value	LB, LBC, LBR, LBMF Series	Inductance change : Within $\pm 10\%$ No significant abnormality in appearance.
	CB, CBC, CBL, CBMF Series	
	LBM Series	
Test Methods and Remarks	Temperature : $60 \pm 2^\circ\text{C}$ Humidity : $90 \sim 95\% \text{RH}$ Duration : 1000 hrs Recovery : At least 2 hrs of recovery under the standard condition after the test, followed by the measurement within 48 hrs.	
19.Loading under damp heat life test		
Specified Value	LB, LBC, LBR, LBMF Series	Inductance change : Within $\pm 10\%$ No significant abnormality in appearance.
	CB, CBC, CBL, CBMF Series	
	LBM Series	
Test Methods and Remarks	Temperature : $60 \pm 2^\circ\text{C}$ Humidity : $90 \sim 95\% \text{RH}$ Duration : 1000 hrs Applied current : Rated current Recovery : At least 2 hrs of recovery under the standard condition after the test, followed by the measurement within 48 hrs.	
20.High temperature life test		
Specified Value	LB, LBC, LBR, LBMF Series	Inductance change : Within $\pm 10\%$ No significant abnormality in appearance.
	CB, CBC, CBL, CBMF Series	
	LBM Series	
Test Methods and Remarks	Temperature : $85 \pm 2^\circ\text{C}$ Duration : 1000 hrs Recovery : At least 2 hrs of recovery under the standard condition after the test, followed by the measurement within 48 hrs.	
21.Loading at high temperature life test		
Specified Value	LB, LBC, LBR, LBMF Series	Inductance change : Within $\pm 10\%$ (LBC3225 Series : Within $\pm 20\%$) No significant abnormality in appearance.
	CB, CBC, CBL, CBMF Series	
	LBM Series	
Test Methods and Remarks	Temperature : $85 \pm 2^\circ\text{C}$ Duration : 1000 hrs Applied current : Rated current Recovery : At least 2 hrs of recovery under the standard condition after the test, followed by the measurement within 48 hrs.	
22.Low temperature life test		
Specified Value	LB, LBC, LBR, LBMF Series	Inductance change : Within $\pm 10\%$ No significant abnormality in appearance.
	CB, CBC, CBL, CBMF Series	
	LBM Series	
Test Methods and Remarks	Temperature : $-40 \pm 2^\circ\text{C}$ Duration : 1000 hrs Recovery : At least 2 hrs of recovery under the standard condition after the test, followed by the measurement within 48 hrs.	
23.Standard condition		
Specified Value	LB, LBC, LBR, LBMF Series	Standard test conditions Unless specified, Ambient temperature is $20 \pm 15^\circ\text{C}$ and the Relative humidity is $65 \pm 20\%$. If there is any doubt about the test results, further measurement shall be had within the following limits: Ambient Temperature: $20 \pm 2^\circ\text{C}$ Relative humidity: $65 \pm 5\%$ Inductance value is based on our standard measurement systems.
	CB, CBC, CBL, CBMF Series	
	LBM Series	

WIRE-WOUND CHIP INDUCTORS (LB SERIES), WIRE-WOUND CHIP POWER INDUCTORS (CB SERIES), WIRE-WOUND CHIP INDUCTORS FOR SIGNAL LINES (LB SERIES M TYPE)

■ PRECAUTIONS

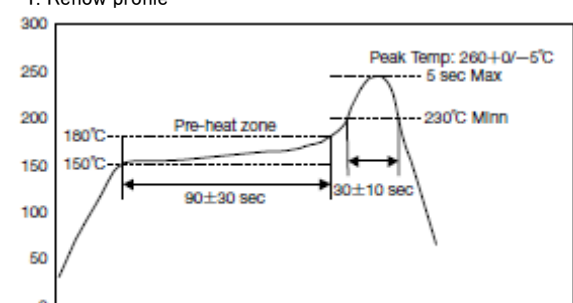
1. Circuit Design	
Precautions	<p>◆Operating environment</p> <p>1. The products described in this specification are intended for use in general electronic equipment, (office supply equipment, telecommunications systems, measuring equipment, and household equipment). They are not intended for use in mission-critical equipment or systems requiring special quality and high reliability (traffic systems, safety equipment, aerospace systems, nuclear control systems and medical equipment including life-support systems,) where product failure might result in loss of life, injury or damage. For such uses, contact TAIYO YUDEN Sales Department in advance.</p>
2. PCB Design	
Precautions	<p>◆Land pattern design</p> <p>1. Please contact any of our offices for a land pattern, and refer to a recommended land pattern of a right figure or specifications.</p>
Technical considerations	<p>PRECAUTIONS 【Recommended Land Patterns】</p> <p>Surface Mounting</p> <ul style="list-style-type: none"> • Mounting and soldering conditions should be checked beforehand. • Applicable soldering process to those products is reflow soldering only.
3. Considerations for automatic placement	
Precautions	<p>◆Adjustment of mounting machine</p> <p>1. Excessive impact load should not be imposed on the products when mounting onto the PC boards.</p> <p>2. Mounting and soldering conditions should be checked beforehand.</p>
Technical considerations	<p>1. When installing products, care should be taken not to apply distortion stress as it may deform the products.</p>
4. Soldering	
Precautions	<p>◆Reflow soldering(LB and CB Types)</p> <p>1. For reflow soldering with either leaded or lead-free solder, the profile specified in "point for controlling" is recommended.</p> <p>◆Recommended conditions for using a soldering iron</p> <p>1. Put the soldering iron on the land-pattern. Soldering iron's temperature - Below 350°C Duration-3 seconds or less. The soldering iron should not come in contact with inductor directly.</p>
Technical considerations	<p>◆Reflow soldering(LB and CB Types)</p> <p>1. Reflow profile</p>  <p>◆Recommended conditions for using a soldering iron</p> <p>1. Components can be damaged by excessive heat where soldering conditions exceed the specified range.</p>
5. Cleaning	
Precautions	<p>◆Cleaning conditions</p> <p>Washing by supersonic waves shall be avoided.</p>
Technical considerations	<p>◆Cleaning conditions</p> <p>If washed by supersonic waves, the products might be broken.</p>

6. Handling

Precautions	<ul style="list-style-type: none"> ◆ Handling <ol style="list-style-type: none"> 1. Keep the inductors away from all magnets and magnetic objects. ◆ Breakaway PC boards (splitting along perforations) <ol style="list-style-type: none"> 1. When splitting the PC board after mounting inductors, care should be taken not to give any stresses of deflection or twisting to the board. 2. Board separation should not be done manually, but by using the appropriate devices. ◆ Mechanical considerations <ol style="list-style-type: none"> 1. Please do not give the inductors any excessive mechanical shocks.
Technical considerations	<ul style="list-style-type: none"> ◆ Handling <ol style="list-style-type: none"> 1. There is a case that a characteristic varies with magnetic influence. ◆ Breakaway PC boards (splitting along perforations) <ol style="list-style-type: none"> 1. Planning pattern configurations and the position of products should be carefully performed to minimize stress. ◆ Mechanical considerations <ol style="list-style-type: none"> 1. There is a case to be damaged by a mechanical shock.

7. Storage conditions

Precautions	<ul style="list-style-type: none"> ◆ Storage <ol style="list-style-type: none"> 1. To maintain the solderability of terminal electrodes and to keep the packing material in good condition, temperature and humidity in the storage area should be controlled. <ul style="list-style-type: none"> • Recommended conditions <ul style="list-style-type: none"> Ambient temperature: 0~40°C / Humidity: Below 70% RH <p>The ambient temperature must be kept below 30°C even under ideal storage conditions, solderability of products electrodes may decrease as time passes. For this reason,</p> <p>LB type: Should be used within 6 months from the time of delivery.</p>
Technical considerations	<ul style="list-style-type: none"> ◆ Storage <ol style="list-style-type: none"> 1. Under a high temperature and humidity environment, problems such as reduced solderability caused by oxidation of terminal electrodes and deterioration of taping/packaging materials may take place.