



Is Now Part of



ON Semiconductor®

To learn more about ON Semiconductor, please visit our website at

www.onsemi.com

ON Semiconductor and the ON Semiconductor logo are trademarks of Semiconductor Components Industries, LLC dba ON Semiconductor or its subsidiaries in the United States and/or other countries. ON Semiconductor owns the rights to a number of patents, trademarks, copyrights, trade secrets, and other intellectual property. A listing of ON Semiconductor's product/patent coverage may be accessed at www.onsemi.com/site/pdf/Patent-Marking.pdf. ON Semiconductor reserves the right to make changes without further notice to any products herein. ON Semiconductor makes no warranty, representation or guarantee regarding the suitability of its products for any particular purpose, nor does ON Semiconductor assume any liability arising out of the application or use of any product or circuit, and specifically disclaims any and all liability, including without limitation special, consequential or incidental damages. Buyer is responsible for its products and applications using ON Semiconductor products, including compliance with all laws, regulations and safety requirements or standards, regardless of any support or applications information provided by ON Semiconductor. "Typical" parameters which may be provided in ON Semiconductor data sheets and/or specifications can and do vary in different applications and actual performance may vary over time. All operating parameters, including "Typicals" must be validated for each customer application by customer's technical experts. ON Semiconductor does not convey any license under its patent rights nor the rights of others. ON Semiconductor products are not designed, intended, or authorized for use as a critical component in life support systems or any FDA Class 3 medical devices or medical devices with a same or similar classification in a foreign jurisdiction or any devices intended for implantation in the human body. Should Buyer purchase or use ON Semiconductor products for any such unintended or unauthorized application, Buyer shall indemnify and hold ON Semiconductor and its officers, employees, subsidiaries, affiliates, and distributors harmless against all claims, costs, damages, and expenses, and reasonable attorney fees arising out of, directly or indirectly, any claim of personal injury or death associated with such unintended or unauthorized use, even if such claim alleges that ON Semiconductor was negligent regarding the design or manufacture of the part. ON Semiconductor is an Equal Opportunity/Affirmative Action Employer. This literature is subject to all applicable copyright laws and is not for resale in any manner.



November 2014

BCP69

PNP General-Purpose Amplifier

Description

This device is designed for general-purpose medium-power amplifiers and switches requiring collector currents to 1.0 A. Sourced from process 77.

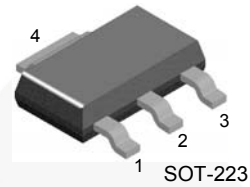

1. Base 2,4. Collector 3. Emitter

Ordering Information

| Part Number | Marking | Package | Packing Method |
|-------------|---------|------------|----------------|
| BCP69 | BCP69 | SOT-223 4L | Tape and Reel |

Absolute Maximum Ratings^{(1),(2)}

Stresses exceeding the absolute maximum ratings may damage the device. The device may not function or be operable above the recommended operating conditions and stressing the parts to these levels is not recommended. In addition, extended exposure to stresses above the recommended operating conditions may affect device reliability. The absolute maximum ratings are stress ratings only. Values are at $T_A = 25^\circ\text{C}$ unless otherwise noted.

| Symbol | Parameter | Value | Unit |
|-----------|--------------------------------|-------------|------------------|
| V_{CEO} | Collector-Emitter Voltage | -20 | V |
| V_{CBO} | Collector-Base Voltage | -30 | V |
| V_{EBO} | Emitter-Base Voltage | -5.0 | V |
| I_C | Collector Current - Continuous | -1.5 | A |
| T_J | Junction Temperature | 150 | $^\circ\text{C}$ |
| T_{STG} | Storage Temperature Range | -55 to +150 | $^\circ\text{C}$ |

Notes:

1. These ratings are based on a maximum junction temperature of 150°C .
2. These are steady-state limits. Fairchild Semiconductor should be consulted on applications involving pulsed or low-duty-cycle operations.

Thermal Characteristics⁽³⁾

Values are at $T_A = 25^\circ\text{C}$ unless otherwise noted.

| Symbol | Parameter | Max. | Unit |
|-----------------|---|------|---------------------------|
| P_D | Total Device Dissipation | 1.0 | W |
| | Derate Above 25°C | 8.0 | mW/ $^\circ\text{C}$ |
| $R_{\theta JA}$ | Thermal Resistance, Junction-to-Ambient | 125 | $^\circ\text{C}/\text{W}$ |

Note:

3. Device is mounted on FR-4 PCB 36 mm × 18 mm × 1.5 mm; mounting pad for the collector lead minimum 6 cm².

Electrical Characteristics⁽⁴⁾

Values are at $T_A = 25^\circ\text{C}$ unless otherwise noted.

| Symbol | Parameter | Conditions | Min. | Typ. | Max. | Unit |
|---------------|--------------------------------------|--|------|------|------|---------------|
| BV_{CEO} | Collector-Emitter Breakdown Voltage | $I_C = -10\text{ mA}$, $I_B = 0$ | -20 | | | V |
| BV_{CBO} | Collector-Base Breakdown Voltage | $I_C = -1.0\text{ mA}$, $I_E = 0$ | -30 | | | V |
| BV_{EBO} | Emitter-Base Breakdown Voltage | $I_E = -100\ \mu\text{A}$, $I_C = 0$ | -5.0 | | | V |
| I_{CBO} | Collector-Base Cut-Off Current | $V_{CB} = -25\text{ V}$, $I_E = 0$ | | | -100 | nA |
| | | $V_{CB} = -25\text{ V}$, $I_E = 0$, $T_J = 150^\circ\text{C}$ | | | -10 | μA |
| I_{EBO} | Emitter-Base Cut-Off Current | $V_{EB} = -5.0\text{ V}$, $I_C = 0$ | | | -100 | nA |
| h_{FE} | DC Current Gain | $I_C = -5\text{ mA}$, $V_{CE} = -1.0\text{ V}$ | 50 | | | |
| | | $I_C = -500\text{ mA}$, $V_{CE} = -1.0\text{ V}$ | 85 | | 375 | |
| | | $I_C = -1.0\text{ A}$, $V_{CE} = -1.0\text{ V}$ | 60 | | | |
| $V_{CE(sat)}$ | Collector-Emitter Saturation Voltage | $I_C = -1.0\text{ A}$, $I_B = -100\text{ mA}$ | | | -0.5 | V |
| $V_{BE(on)}$ | Base-Emitter On Voltage | $I_C = -1.0\text{ A}$, $V_{CE} = -1.0\text{ V}$ | | | -1.0 | V |
| C_{cb} | Collector-Base Capacitance | $V_{CB} = -10\text{ V}$, $I_E = 0$, $f = 1.0\text{ MHz}$ | | | 30 | pF |
| h_{fe} | Small-Signal Current Gain | $I_C = -50\text{ mA}$, $V_{CE} = -10\text{ V}$, $f = 20\text{ MHz}$ | 2.5 | | | |

Note:

4. Pulse test: pulse width $\leq 300\ \mu\text{s}$, duty cycle $\leq 2.0\%$

Typical Performance Characteristics

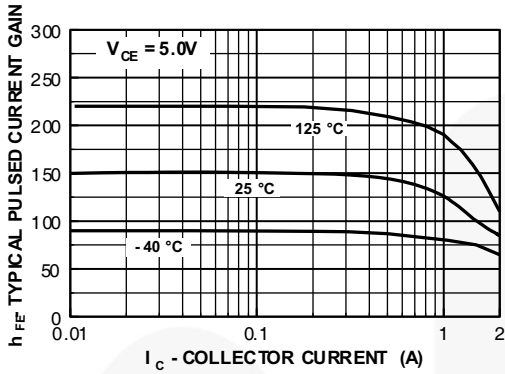

Figure 1. Typical Pulsed Current Gain vs. Collector Current

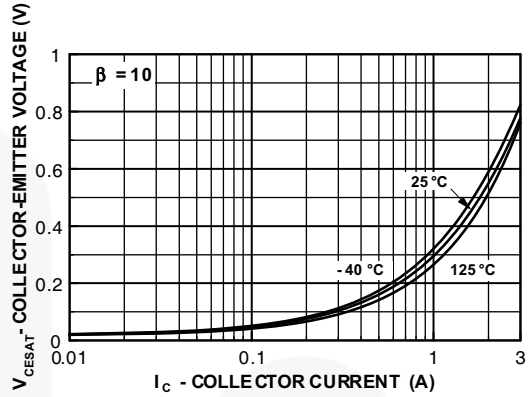

Figure 2. Collector-Emitter Saturation Voltage vs. Collector Current

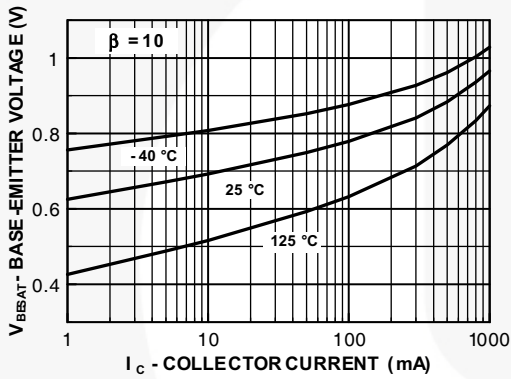

Figure 3. Base-Emitter Saturation Voltage vs. Collector Current

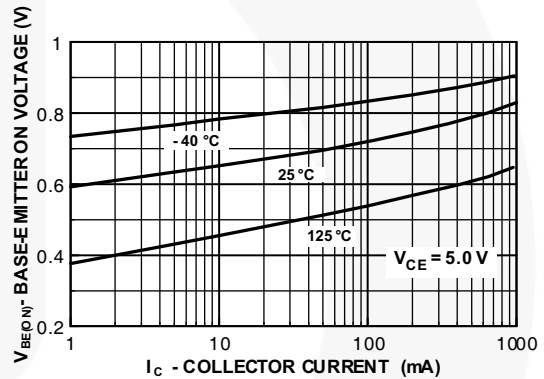

Figure 4. Base Emitter On Voltage vs. Collector Current

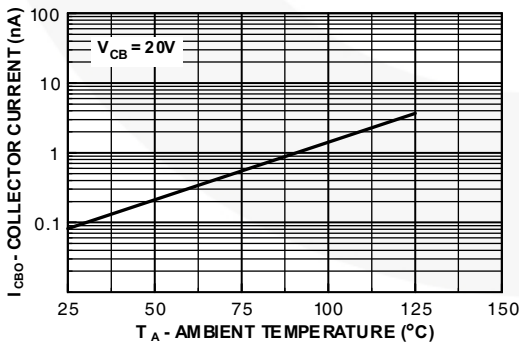

Figure 5. Collector Cut-Off Current vs. Ambient Temperature

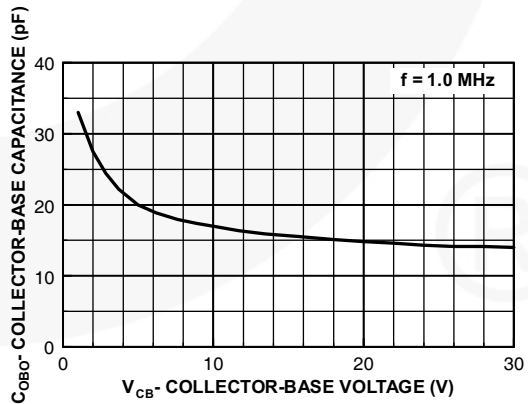

Figure 6. Collector-Base Capacitance vs. Collector-Base Voltage

Typical Performance Characteristics (Continued)

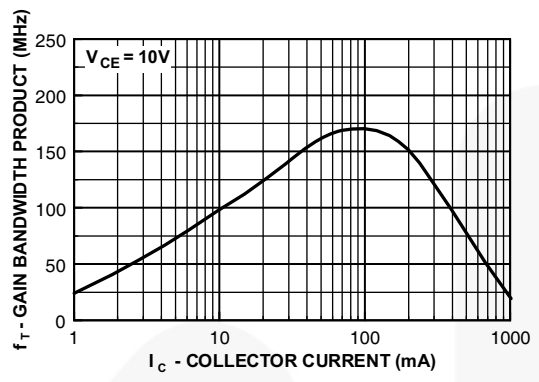

Figure 7. Gain Bandwidth Product vs. Collector Current

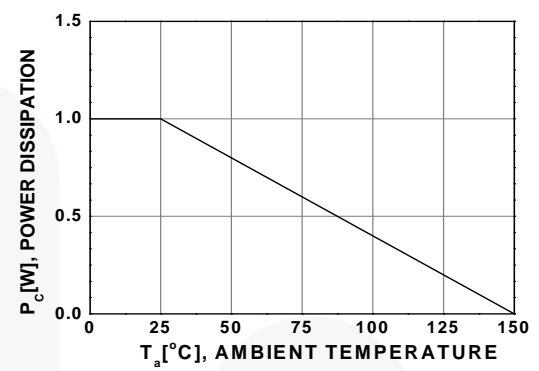
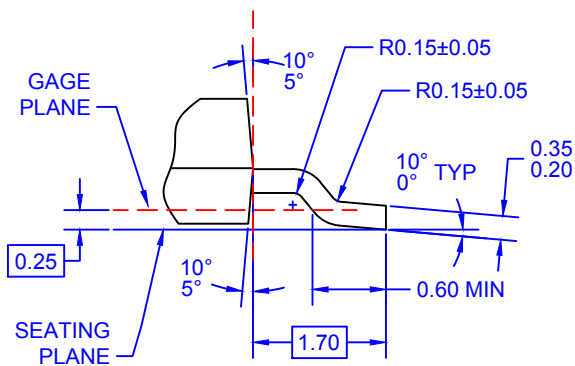

Figure 8. Power Dissipation vs. Ambient Temperature





LAND PATTERN RECOMMENDATION



DETAIL A
SCALE: 2:1

- NOTES: UNLESS OTHERWISE SPECIFIED
 A) DRAWING BASED ON JEDEC REGISTRATION TO-261C, VARIATION AA.
 B) ALL DIMENSIONS ARE IN MILLIMETERS.
 C) DIMENSIONS DO NOT INCLUDE BURRS OR MOLD FLASH. MOLD FLASH OR BURRS DOES NOT EXCEED 0.10MM.
 D) DIMENSIONING AND TOLERANCING PER ASME Y14.5M-2009.
 E) LANDPATTERN NAME: SOT230P700X180-4BN
 F) DRAWING FILENAME: MKT-MA04AREV3



ON Semiconductor and  are trademarks of Semiconductor Components Industries, LLC dba ON Semiconductor or its subsidiaries in the United States and/or other countries. ON Semiconductor owns the rights to a number of patents, trademarks, copyrights, trade secrets, and other intellectual property. A listing of ON Semiconductor's product/patent coverage may be accessed at www.onsemi.com/site/pdf/Patent-Marking.pdf. ON Semiconductor reserves the right to make changes without further notice to any products herein. ON Semiconductor makes no warranty, representation or guarantee regarding the suitability of its products for any particular purpose, nor does ON Semiconductor assume any liability arising out of the application or use of any product or circuit, and specifically disclaims any and all liability, including without limitation special, consequential or incidental damages. Buyer is responsible for its products and applications using ON Semiconductor products, including compliance with all laws, regulations and safety requirements or standards, regardless of any support or applications information provided by ON Semiconductor. "Typical" parameters which may be provided in ON Semiconductor data sheets and/or specifications can and do vary in different applications and actual performance may vary over time. All operating parameters, including "Typicals" must be validated for each customer application by customer's technical experts. ON Semiconductor does not convey any license under its patent rights nor the rights of others. ON Semiconductor products are not designed, intended, or authorized for use as a critical component in life support systems or any FDA Class 3 medical devices or medical devices with a same or similar classification in a foreign jurisdiction or any devices intended for implantation in the human body. Should Buyer purchase or use ON Semiconductor products for any such unintended or unauthorized application, Buyer shall indemnify and hold ON Semiconductor and its officers, employees, subsidiaries, affiliates, and distributors harmless against all claims, costs, damages, and expenses, and reasonable attorney fees arising out of, directly or indirectly, any claim of personal injury or death associated with such unintended or unauthorized use, even if such claim alleges that ON Semiconductor was negligent regarding the design or manufacture of the part. ON Semiconductor is an Equal Opportunity/Affirmative Action Employer. This literature is subject to all applicable copyright laws and is not for resale in any manner.

PUBLICATION ORDERING INFORMATION

LITERATURE FULFILLMENT:

Literature Distribution Center for ON Semiconductor
19521 E. 32nd Pkwy, Aurora, Colorado 80011 USA
Phone: 303-675-2175 or 800-344-3860 Toll Free USA/Canada
Fax: 303-675-2176 or 800-344-3867 Toll Free USA/Canada
Email: orderlit@onsemi.com

N. American Technical Support: 800-282-9855 Toll Free
USA/Canada
Europe, Middle East and Africa Technical Support:
Phone: 421 33 790 2910
Japan Customer Focus Center
Phone: 81-3-5817-1050

ON Semiconductor Website: www.onsemi.com
Order Literature: <http://www.onsemi.com/orderlit>
For additional information, please contact your local
Sales Representative