

# NGTB30N60FLWG

## IGBT

This Insulated Gate Bipolar Transistor (IGBT) features a robust and cost effective Trench construction, and provides superior performance in demanding switching applications, offering both low on state voltage and minimal switching loss.

### Features

- Low Saturation Voltage using Trench with Field Stop Technology
- Low Switching Loss Reduces System Power Dissipation
- Soft Fast Reverse Recovery Diode
- Optimized for High Speed Switching
- 5  $\mu$ s Short-Circuit Capability
- These are Pb-Free Devices

### Typical Applications

- Solar Inverters
- Uninterruptable Power Supply (UPS)

### ABSOLUTE MAXIMUM RATINGS

| Rating  | Symbol           | Value                | Unit             |
|---|------------------|----------------------|------------------|
| Collector-emitter voltage   | $V_{CES}$        | 600                  | V                |
| Collector current<br>@ $T_C = 25^\circ\text{C}$<br>@ $T_C = 100^\circ\text{C}$                                      | $I_C$            | 60<br>30             | A                |
| Pulsed collector current, $T_{\text{pulse}}$<br>limited by $T_{J\text{max}}$  | $I_{CM}$         | 120                  | A                |
| Diode Forward Current<br>@ $T_C = 25^\circ\text{C}$<br>@ $T_C = 100^\circ\text{C}$                                  | $I_F$            | 60<br>30             | A                |
| Diode Pulsed Current<br>$T_{\text{pulse}}$ Limited by $T_{J\text{max}}$   | $I_{FM}$         | 120                  | A                |
| Short-circuit withstand time<br>$V_{GE} = 15\text{ V}$ , $V_{CE} = 300\text{ V}$ ,<br>$T_J \leq +150^\circ\text{C}$ | $t_{SC}$         | 5                    | $\mu\text{s}$    |
| Gate-emitter voltage<br>Transient Gate Emitter Voltage<br>( $t_p = 5\ \mu\text{s}$ , $D < 0.010$ )                  | $V_{GE}$         | $\pm 20$<br>$\pm 30$ | V                |
| Power Dissipation<br>@ $T_C = 25^\circ\text{C}$<br>@ $T_C = 100^\circ\text{C}$                                      | $P_D$            | 250<br>67            | W                |
| Operating junction temperature range  | $T_J$            | -55 to +150          | $^\circ\text{C}$ |
| Storage temperature range   | $T_{\text{stg}}$ | -55 to +150          | $^\circ\text{C}$ |
| Lead temperature for soldering, 1/8"<br>from case for 5 seconds   | $T_{\text{SLD}}$ | 260                  | $^\circ\text{C}$ |

Stresses exceeding Maximum Ratings may damage the device. Maximum Ratings are stress ratings only. Functional operation above the Recommended Operating Conditions is not implied. Extended exposure to stresses above the Recommended Operating Conditions may affect device reliability.



**ON Semiconductor**<sup>®</sup>

<http://onsemi.com>

**30 A, 600 V**  
 **$V_{CEsat} = 1.65\text{ V}$**

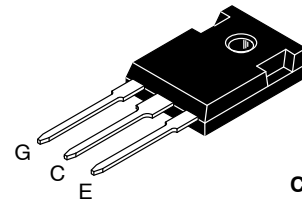
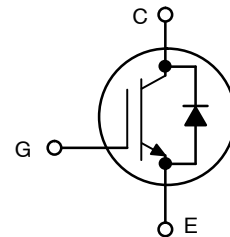

**TO-247  
CASE 340L  
STYLE 4**

### MARKING DIAGRAM

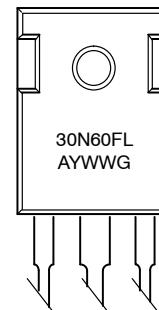

A = Assembly Location  
Y = Year  
WW = Work Week  
G = Pb-Free Package

### ORDERING INFORMATION

| Device        | Package             | Shipping        |
|---------------|---------------------|-----------------|
| NGTB30N60FLWG | TO-247<br>(Pb-Free) | 30 Units / Rail |

# NGTB30N60FLWG

## THERMAL CHARACTERISTICS

| Rating   | Symbol          | Value | Unit                        |
|--|-----------------|-------|-----------------------------|
| Thermal resistance junction-to-case, for IGBT  | $R_{\theta JC}$ | 0.486 | $^{\circ}\text{C}/\text{W}$ |
| Thermal resistance junction-to-case, for Diode | $R_{\theta JC}$ | 1.06  | $^{\circ}\text{C}/\text{W}$ |
| Thermal resistance junction-to-ambient         | $R_{\theta JA}$ | 40    | $^{\circ}\text{C}/\text{W}$ |

## ELECTRICAL CHARACTERISTICS ( $T_J = 25^{\circ}\text{C}$ unless otherwise specified)

| Parameter | Test Conditions | Symbol | Min | Typ | Max | Unit |
|-----------|-----------------|--------|-----|-----|-----|------|
|-----------|-----------------|--------|-----|-----|-----|------|

### STATIC CHARACTERISTIC

|   |   |               |          |             |          |    |
|---|---|---------------|----------|-------------|----------|----|
| Collector-emitter breakdown voltage, gate-emitter short-circuited | $V_{GE} = 0\text{ V}, I_C = 500\ \mu\text{A}$   | $V_{(BR)CES}$ | 600      | -           | -        | V  |
| Collector-emitter saturation voltage                              | $V_{GE} = 15\text{ V}, I_C = 30\text{ A}$<br>$V_{GE} = 15\text{ V}, I_C = 30\text{ A}, T_J = 150^{\circ}\text{C}$       | $V_{CEsat}$   | 1.4<br>- | 1.65<br>2.0 | 1.9<br>- | V  |
| Gate-emitter threshold voltage                                    | $V_{GE} = V_{CE}, I_C = 200\ \mu\text{A}$   | $V_{GE(th)}$  | 4.5      | 5.5         | 6.5      | V  |
| Collector-emitter cut-off current, gate-emitter short-circuited   | $V_{GE} = 0\text{ V}, V_{CE} = 600\text{ V}$<br>$V_{GE} = 0\text{ V}, V_{CE} = 600\text{ V}, T_J = 150^{\circ}\text{C}$ | $I_{CES}$     | -<br>-   | -<br>-      | 0.2<br>2 | mA |
| Gate leakage current, collector-emitter short-circuited           | $V_{GE} = 20\text{ V}, V_{CE} = 0\text{ V}$   | $I_{GES}$     | -        | -           | 100      | nA |

### DYNAMIC CHARACTERISTIC

|                              |  |           |   |      |   |    |
|------------------------------|--|-----------|---|------|---|----|
| Input capacitance            | $V_{CE} = 20\text{ V}, V_{GE} = 0\text{ V}, f = 1\text{ MHz}$    | $C_{ies}$ | - | 4200 | - | pF |
| Output capacitance           |  | $C_{oes}$ | - | 170  | - |    |
| Reverse transfer capacitance |  | $C_{res}$ | - | 110  | - |    |
| Gate charge total            | $V_{CE} = 480\text{ V}, I_C = 30\text{ A}, V_{GE} = 15\text{ V}$ | $Q_g$     | - | 170  | - | nC |
| Gate to emitter charge       |  | $Q_{ge}$  | - | 34   | - |    |
| Gate to collector charge     |  | $Q_{gc}$  | - | 83   | - |    |

### SWITCHING CHARACTERISTIC, INDUCTIVE LOAD

|                         |  |              |   |      |   |    |
|-------------------------|--|--------------|---|------|---|----|
| Turn-on delay time      | $T_J = 25^{\circ}\text{C}$<br>$V_{CC} = 400\text{ V}, I_C = 30\text{ A}$<br>$R_g = 10\ \Omega$<br>$V_{GE} = 0\text{ V}/15\text{ V}$  | $t_{d(on)}$  | - | 83   | - | ns |
| Rise time               |  | $t_r$        | - | 31   | - |    |
| Turn-off delay time     |  | $t_{d(off)}$ | - | 170  | - |    |
| Fall time               |  | $t_f$        | - | 80   | - |    |
| Turn-on switching loss  |  | $E_{on}$     | - | 0.7  | - | mJ |
| Turn-off switching loss |  | $E_{off}$    | - | 0.28 | - |    |
| Total switching loss    |  | $E_{ts}$     | - | 0.98 | - |    |
| Turn-on delay time      | $T_J = 150^{\circ}\text{C}$<br>$V_{CC} = 400\text{ V}, I_C = 30\text{ A}$<br>$R_g = 10\ \Omega$<br>$V_{GE} = 0\text{ V}/15\text{ V}$ | $t_{d(on)}$  | - | 81   | - | ns |
| Rise time               |  | $t_r$        | - | 32   | - |    |
| Turn-off delay time     |  | $t_{d(off)}$ | - | 180  | - |    |
| Fall time               |  | $t_f$        | - | 110  | - |    |
| Turn-on switching loss  |  | $E_{on}$     | - | 0.82 | - | mJ |
| Turn-off switching loss |  | $E_{off}$    | - | 0.63 | - |    |
| Total switching loss    |  | $E_{ts}$     | - | 1.45 | - |    |

# NGTB30N60FLWG

## ELECTRICAL CHARACTERISTICS ( $T_J = 25^\circ\text{C}$ unless otherwise specified)

| Parameter                   | Test Conditions   | Symbol    | Min       | Typ        | Max       | Unit          |
|-----------------------------|---|-----------|-----------|------------|-----------|---------------|
| <b>DIODE CHARACTERISTIC</b> |   |           |           |            |           |               |
| Forward voltage             | $V_{GE} = 0\text{ V}, I_F = 30\text{ A}$<br>$V_{GE} = 0\text{ V}, I_F = 30\text{ A}, T_J = 150^\circ\text{C}$ | $V_F$     | 1.45<br>– | 1.9<br>2.0 | 2.35<br>– | V             |
| Reverse recovery time       | $T_J = 25^\circ\text{C}$<br>$I_F = 30\text{ A}, V_R = 200\text{ V}$<br>$di_F/dt = 200\text{ A}/\mu\text{s}$   | $t_{rr}$  | –         | 72         | –         | ns            |
| Reverse recovery charge     |   | $Q_{rr}$  | –         | 0.25       | –         | $\mu\text{C}$ |
| Reverse recovery current    |   | $I_{rrm}$ | –         | 6          | –         | A             |

# NGTB30N60FLWG

## TYPICAL CHARACTERISTICS

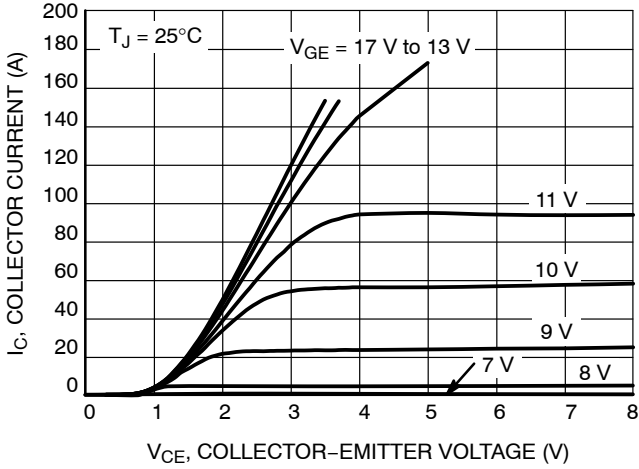

Figure 1. Output Characteristics

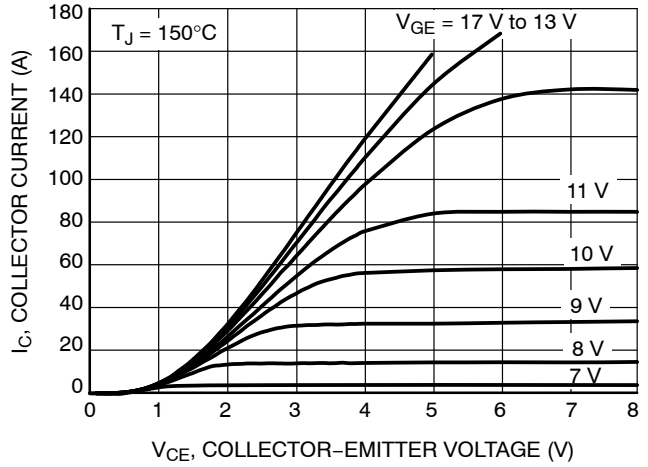

Figure 2. Output Characteristics

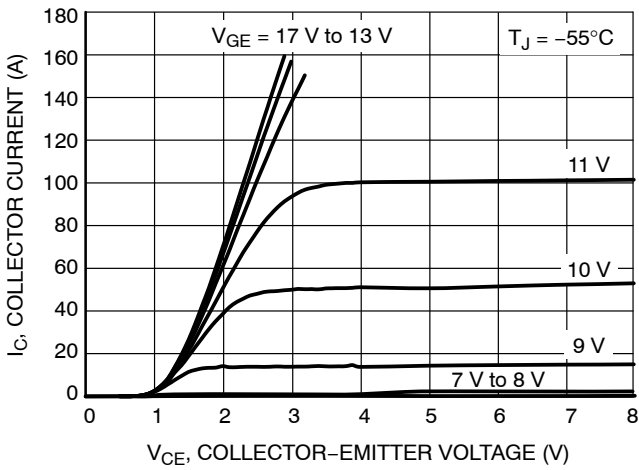

Figure 3. Output Characteristics

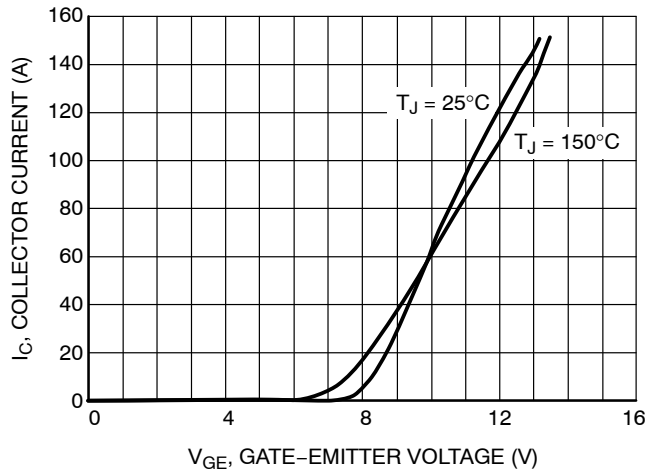

Figure 4. Typical Transfer Characteristics

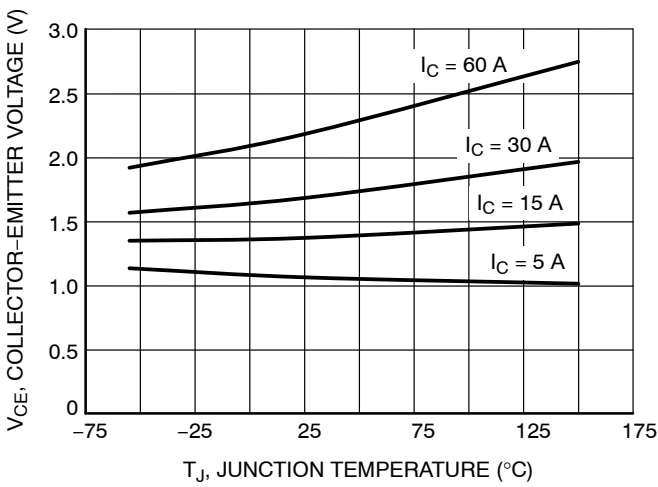

Figure 5.  $V_{CE(sat)}$  vs.  $T_J$

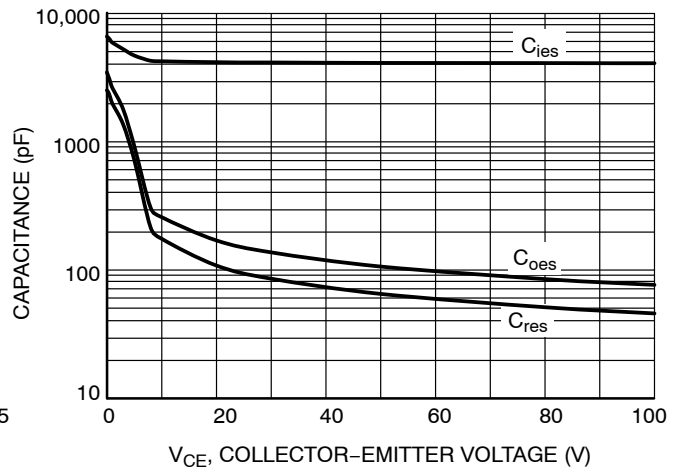

Figure 6. Typical Capacitance

# NGTB30N60FLWG

## TYPICAL CHARACTERISTICS

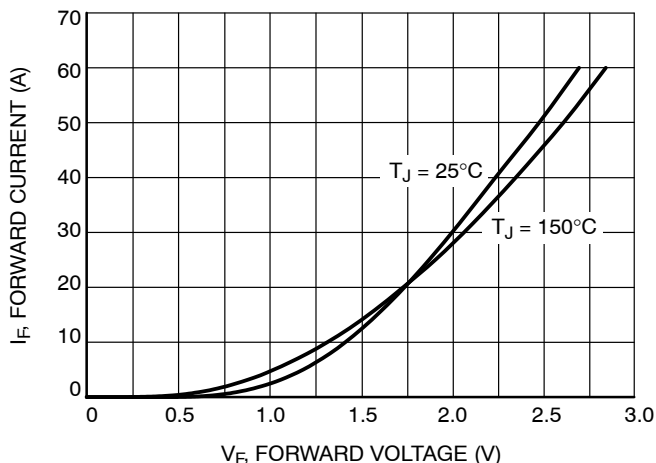

Figure 7. Diode Forward Characteristics

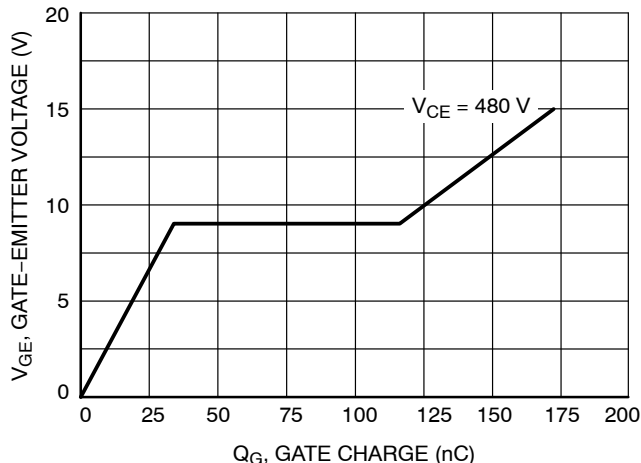

Figure 8. Typical Gate Charge

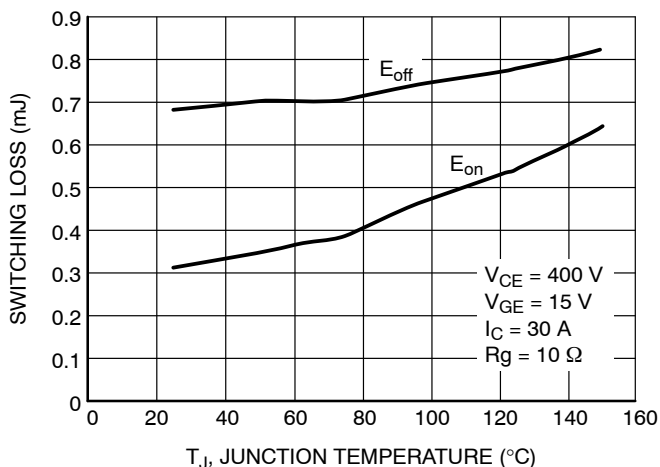

Figure 9. Switching Loss vs. Temperature

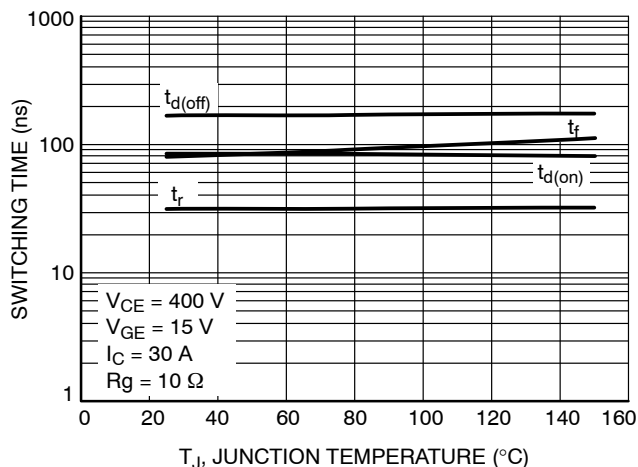

Figure 10. Switching Time vs. Temperature

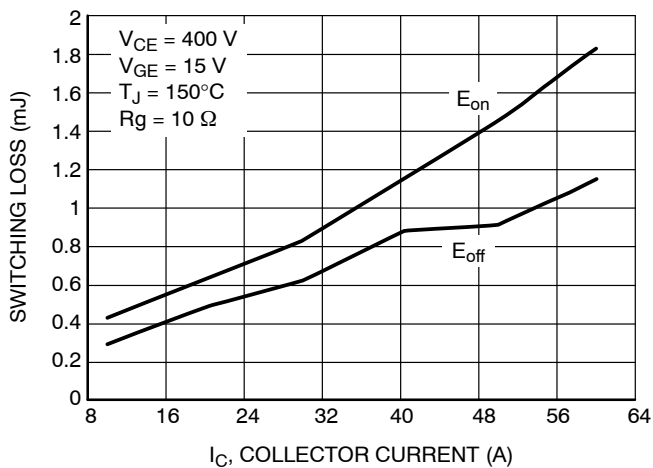

Figure 11. Switching Loss vs.  $I_C$

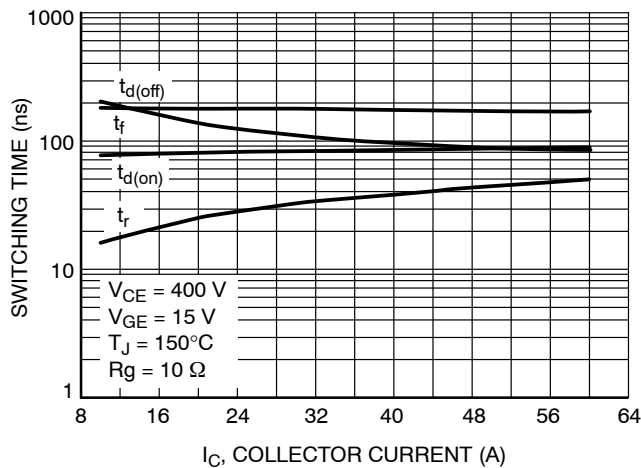

Figure 12. Switching Time vs.  $I_C$

# NGTB30N60FLWG

## TYPICAL CHARACTERISTICS

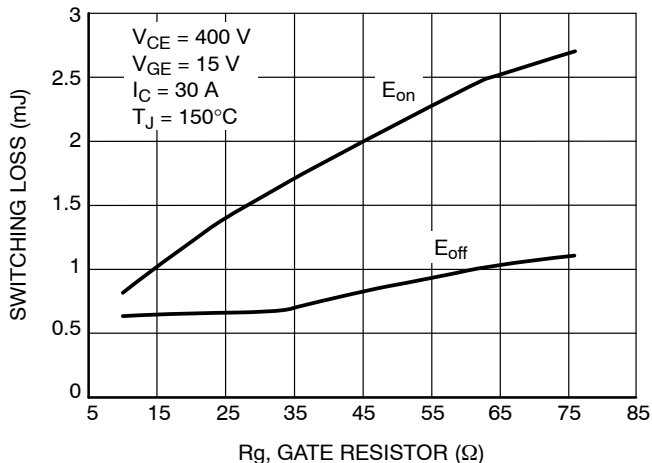

Figure 13. Switching Loss vs. Rg

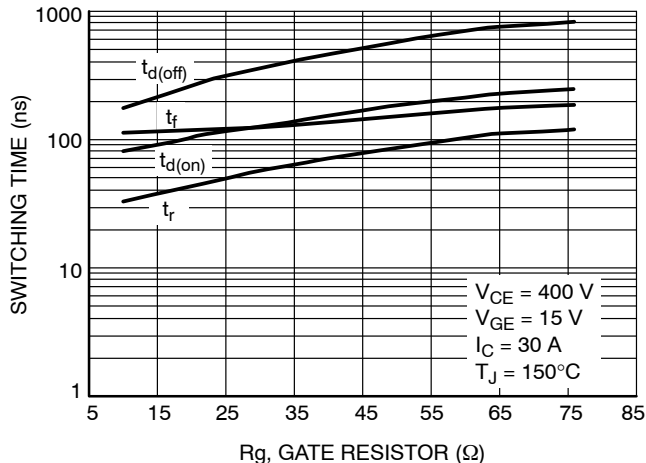

Figure 14. Switching Time vs. Rg

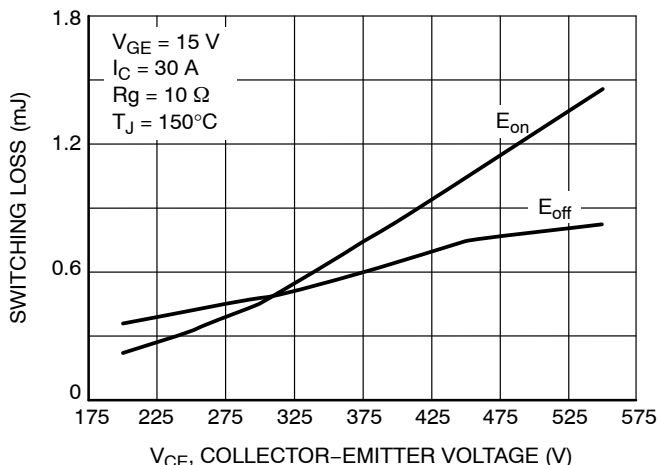

Figure 15. Switching Loss vs. V<sub>CE</sub>

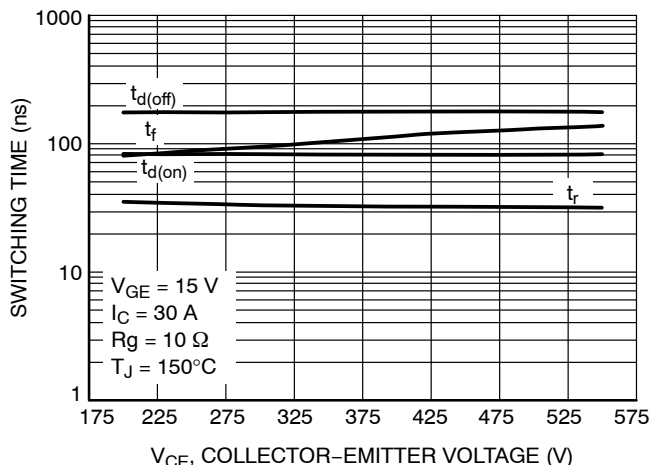

Figure 16. Switching Time vs. V<sub>CE</sub>

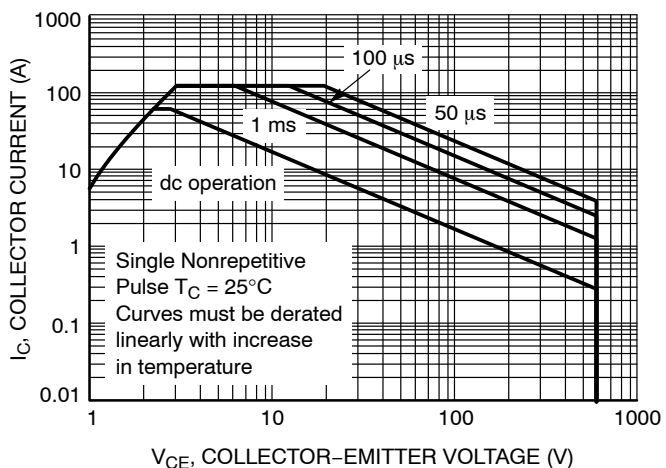

Figure 17. Safe Operating Area

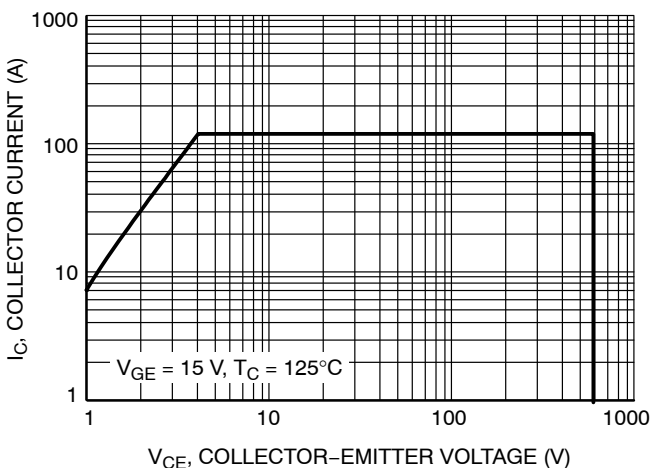

Figure 18. Reverse Bias Safe Operating Area

# NGTB30N60FLWG

## TYPICAL CHARACTERISTICS

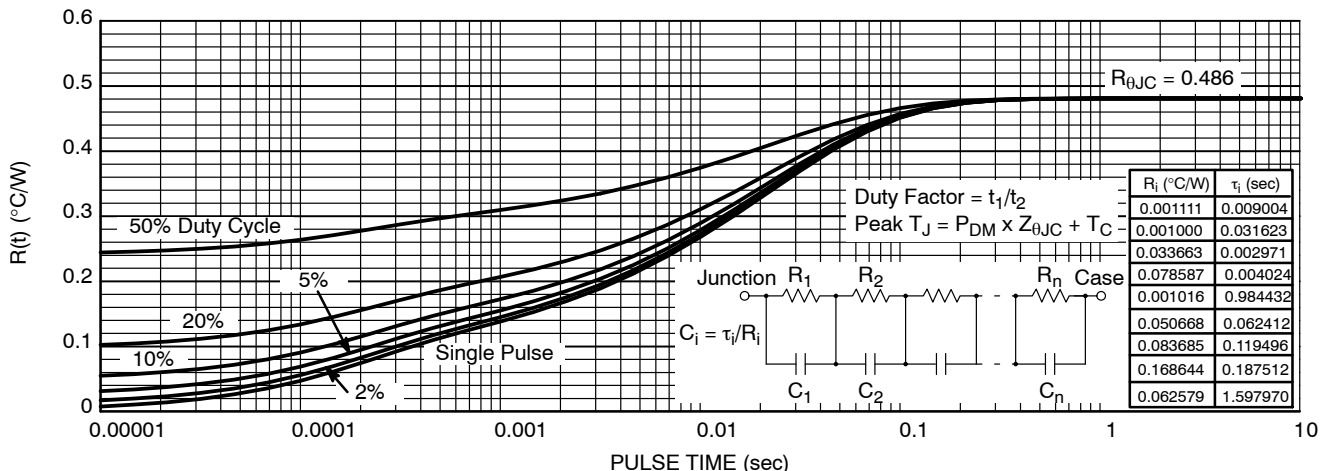

Figure 19. IGBT Transient Thermal Impedance

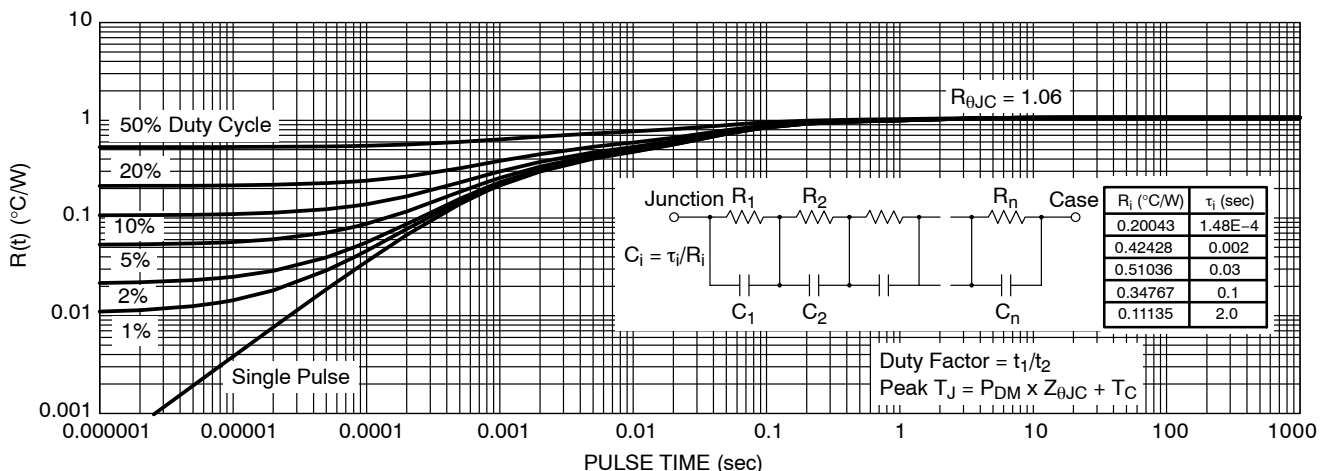

Figure 20. Diode Transient Thermal Impedance

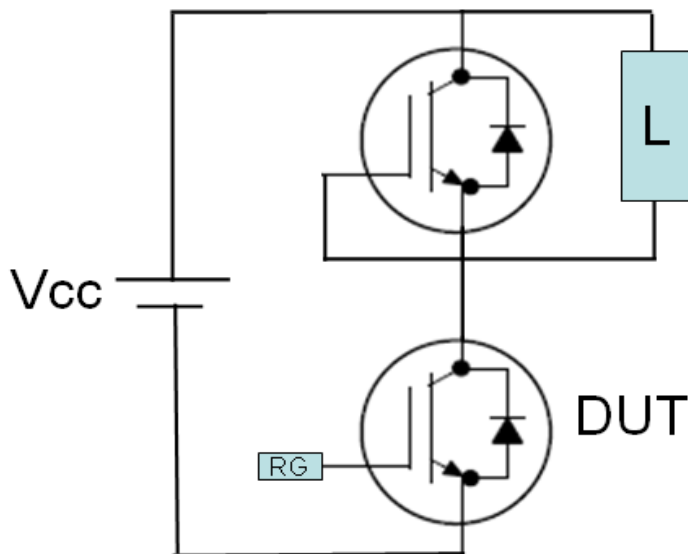

Figure 21. Test Circuit for Switching Characteristics

# NGTB30N60FLWG



Figure 22. Definition of Turn On Waveform



# NGTB30N60FLWG

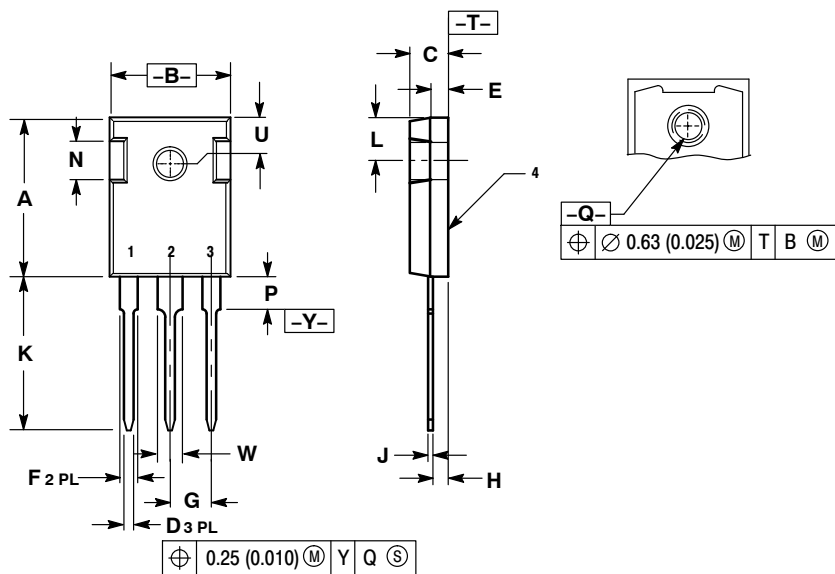

Figure 23. Definition of Turn Off Waveform

# NGTB30N60FLWG

## PACKAGE DIMENSIONS

TO-247  
CASE 340L-02  
ISSUE F



- NOTES:  
1. DIMENSIONING AND TOLERANCING PER ANSI Y14.5M, 1982.  
2. CONTROLLING DIMENSION: MILLIMETER.

| DIM | MILLIMETERS |       | INCHES    |       |
|-----|-------------|-------|-----------|-------|
|     | MIN         | MAX   | MIN       | MAX   |
| A   | 20.32       | 21.08 | 0.800     | 0.830 |
| B   | 15.75       | 16.26 | 0.620     | 0.640 |
| C   | 4.70        | 5.30  | 0.185     | 0.209 |
| D   | 1.00        | 1.40  | 0.040     | 0.055 |
| E   | 1.90        | 2.60  | 0.075     | 0.102 |
| F   | 1.65        | 2.13  | 0.065     | 0.084 |
| G   | 5.45 BSC    |       | 0.215 BSC |       |
| H   | 1.50        | 2.49  | 0.059     | 0.098 |
| J   | 0.40        | 0.80  | 0.016     | 0.031 |
| K   | 19.81       | 20.83 | 0.780     | 0.820 |
| L   | 5.40        | 6.20  | 0.212     | 0.244 |
| N   | 4.32        | 5.49  | 0.170     | 0.216 |
| P   | ---         | 4.50  | ---       | 0.177 |
| Q   | 3.55        | 3.65  | 0.140     | 0.144 |
| U   | 6.15 BSC    |       | 0.242 BSC |       |
| W   | 2.87        | 3.12  | 0.113     | 0.123 |

- STYLE 4:  
PIN 1. GATE  
2. COLLECTOR  
3. EMITTER  
4. COLLECTOR

ON Semiconductor and are registered trademarks of Semiconductor Components Industries, LLC (SCILLC). SCILLC owns the rights to a number of patents, trademarks, copyrights, trade secrets, and other intellectual property. A listing of SCILLC's product/patent coverage may be accessed at [www.onsemi.com/site/pdf/Patent-Marking.pdf](http://www.onsemi.com/site/pdf/Patent-Marking.pdf). SCILLC reserves the right to make changes without further notice to any products herein. SCILLC makes no warranty, representation or guarantee regarding the suitability of its products for any particular purpose, nor does SCILLC assume any liability arising out of the application or use of any product or circuit, and specifically disclaims any and all liability, including without limitation special, consequential or incidental damages. "Typical" parameters which may be provided in SCILLC data sheets and/or specifications can and do vary in different applications and actual performance may vary over time. All operating parameters, including "Typicals" must be validated for each customer application by customer's technical experts. SCILLC does not convey any license under its patent rights nor the rights of others. SCILLC products are not designed, intended, or authorized for use as components in systems intended for surgical implant into the body, or other applications intended to support or sustain life, or for any other application in which the failure of the SCILLC product could create a situation where personal injury or death may occur. Should Buyer purchase or use SCILLC products for any such unintended or unauthorized application, Buyer shall indemnify and hold SCILLC and its officers, employees, subsidiaries, affiliates, and distributors harmless against all claims, costs, damages, and expenses, and reasonable attorney fees arising out of, directly or indirectly, any claim of personal injury or death associated with such unintended or unauthorized use, even if such claim alleges that SCILLC was negligent regarding the design or manufacture of the part. SCILLC is an Equal Opportunity/Affirmative Action Employer. This literature is subject to all applicable copyright laws and is not for resale in any manner.

### PUBLICATION ORDERING INFORMATION

#### LITERATURE FULFILLMENT:

Literature Distribution Center for ON Semiconductor  
P.O. Box 5163, Denver, Colorado 80217 USA  
Phone: 303-675-2175 or 800-344-3860 Toll Free USA/Canada  
Fax: 303-675-2176 or 800-344-3867 Toll Free USA/Canada  
Email: [orderlit@onsemi.com](mailto:orderlit@onsemi.com)

N. American Technical Support: 800-282-9855 Toll Free  
USA/Canada  
Europe, Middle East and Africa Technical Support:  
Phone: 421 33 790 2910  
Japan Customer Focus Center  
Phone: 81-3-5817-1050

ON Semiconductor Website: [www.onsemi.com](http://www.onsemi.com)  
Order Literature: <http://www.onsemi.com/orderlit>

For additional information, please contact your local  
Sales Representative