

**NPN Silicon RF Transistor**

- For highest gain low noise amplifier at 1.8 GHz
- Outstanding  $G_{ms} = 20$  dB  
Noise Figure  $F = 0.9$  dB
- Gold metallization for high reliability
- SIEGET 45 - Line

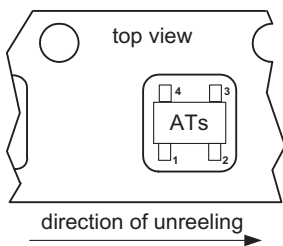
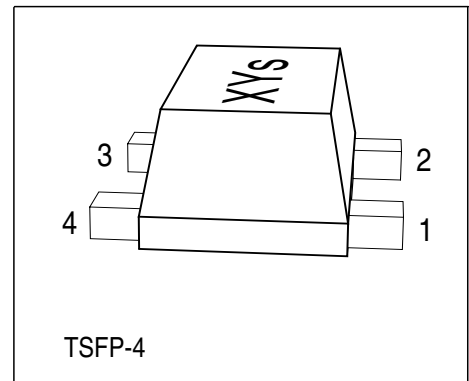

**ESD: Electrostatic discharge sensitive device, observe handling precaution!**

Type	Marking	Pin Configuration						Package
BFP540F	ATs*	1=B	2=E	3=C	4=E	-	-	TSFP-4

\* Pin configuration fixed relative to marking (see package picture)

**Maximum Ratings**

Parameter	Symbol	Value	Unit
Collector-emitter voltage	$V_{CEO}$	4.5	V
Collector-emitter voltage	$V_{CES}$	14	
Collector-base voltage	$V_{CBO}$	14	
Emitter-base voltage	$V_{EBO}$	1	
Collector current	$I_C$	80	mA
Base current	$I_B$	8	
Total power dissipation <sup>1)</sup> $T_S \leq 80^\circ\text{C}$	$P_{tot}$	250	mW
Junction temperature	$T_j$	150	
Ambient temperature	$T_A$	-65 ... 150	
Storage temperature	$T_{stg}$	-65 ... 150	

**Thermal Resistance**

Parameter	Symbol	Value	Unit
Junction - soldering point <sup>2)</sup>	$R_{thJS}$	$\leq 280$	K/W

<sup>1)</sup>  $T_S$  is measured on the collector lead at the soldering point to the pcb

<sup>2)</sup> For calculation of  $R_{thJA}$  please refer to Application Note Thermal Resistance

**Electrical Characteristics** at  $T_A = 25^\circ\text{C}$ , unless otherwise specified

Parameter	Symbol	Values			Unit
		min.	typ.	max.	
<b>DC Characteristics</b>					
Collector-emitter breakdown voltage $I_C = 1\text{ mA}, I_B = 0$	$V_{(BR)CEO}$	4.5	5	-	V
Collector-emitter cutoff current $V_{CE} = 14\text{ V}, V_{BE} = 0$	$I_{CES}$	-	-	10	$\mu\text{A}$
Collector-base cutoff current $V_{CB} = 5\text{ V}, I_E = 0$	$I_{CBO}$	-	-	100	nA
Emitter-base cutoff current $V_{EB} = 0.5\text{ V}, I_C = 0$	$I_{EBO}$	-	-	10	$\mu\text{A}$
DC current gain $I_C = 20\text{ mA}, V_{CE} = 3.5\text{ V}$	$h_{FE}$	50	110	200	-

**Electrical Characteristics at  $T_A = 25^\circ\text{C}$ , unless otherwise specified**

Parameter	Symbol	Values			Unit
		min.	typ.	max.	
<b>AC Characteristics (verified by random sampling)</b>					
Transition frequency $I_C = 50\text{ mA}$ , $V_{CE} = 4\text{ V}$ , $f = 1\text{ GHz}$	$f_T$	21	30	-	GHz
Collector-base capacitance $V_{CB} = 2\text{ V}$ , $f = 1\text{ MHz}$	$C_{cb}$	-	0.14	0.24	pF
Collector emitter capacitance $V_{CE} = 2\text{ V}$ , $f = 1\text{ MHz}$	$C_{ce}$	-	0.3	-	
Emitter-base capacitance $V_{EB} = 0.5\text{ V}$ , $f = 1\text{ MHz}$	$C_{eb}$	-	0.6	-	
Noise figure $I_C = 5\text{ mA}$ , $V_{CE} = 2\text{ V}$ , $f = 1.8\text{ GHz}$ , $Z_S = Z_{Sopt}$ $I_C = 5\text{ mA}$ , $V_{CE} = 2\text{ V}$ , $f = 3\text{ GHz}$ , $Z_S = Z_{Sopt}$	$F$	-	0.9	1.4	dB
		-	1.3	-	
Power gain, maximum available <sup>1)</sup> $I_C = 20\text{ mA}$ , $V_{CE} = 2\text{ V}$ , $Z_S = Z_{Sopt}$ , $Z_L = Z_{Lopt}$ , $f = 1.8\text{ GHz}$ $I_C = 20\text{ mA}$ , $V_{CE} = 2\text{ V}$ , $Z_S = Z_{Sopt}$ , $Z_L = Z_{Lopt}$ , $f = 3\text{ GHz}$	$G_{ma}$	-	20	-	
		-	14.5	-	
Transducer gain $I_C = 20\text{ mA}$ , $V_{CE} = 2\text{ V}$ , $Z_S = Z_L = 50\ \Omega$ , $f = 1.8\text{ GHz}$ $I_C = 20\text{ mA}$ , $V_{CE} = 2\text{ V}$ , $Z_S = Z_L = 50\ \Omega$ , $f = 3\text{ GHz}$	$ S_{21e} ^2$	15.5	18	-	dB
		-	13	-	
Third order intercept point at output <sup>2)</sup> $V_{CE} = 2\text{ V}$ , $I_C = 20\text{ mA}$ , $f = 1.8\text{ GHz}$ , $Z_S = Z_L = 50\ \Omega$	$IP_3$	-	24.5	-	dBm
1dB Compression point at output $I_C = 20\text{ mA}$ , $V_{CE} = 2\text{ V}$ , $Z_S = Z_L = 50\ \Omega$ , $f = 1.8\text{ GHz}$	$P_{-1dB}$	-	11	-	

$$^1G_{ma} = |S_{21e} / S_{12e}| (k - (k^2 - 1)^{1/2}), G_{ms} = |S_{21e} / S_{12e}|$$

<sup>2</sup>IP3 value depends on termination of all intermodulation frequency components.  
Termination used for this measurement is 50Ω from 0.1 MHz to 6 GHz

**SPICE Parameter (Gummel-Poon Model, Berkley-SPICE 2G.6 Syntax):**
**Transistor Chip Data:**

IS =	82.84	aA	BF =	107.5	-	NF =	1	-
VAF =	28.383	V	IKF =	0.48731	A	ISE =	11.15	fA
NE =	3.19	-	BR =	5.5	-	NR =	1	-
VAR =	19.705	V	IKR =	0.02	A	ISC =	19.237	aA
NC =	1.172	-	RB =	5.4	$\Omega$	IRB =	0.72983	mA
RBM =	1.3	$\Omega$	RE =	0.31111	-	RC =	4	$\Omega$
CJE =	1.8063	fF	VJE =	0.8051	V	MJE =	0.46576	-
TF =	6.76	ps	XTF =	0.4219	-	VTF =	0.23794	V
ITF =	1	mA	PTF =	0	deg	CJC =	234	fF
VJC =	0.81969	V	MJC =	0.30232	-	XCJC =	0.3	-
TR =	2.324	ns	CJS =	0	fF	VJS =	0.75	V
MJS =	0	-	XTB =	0	-	EG =	1.11	eV
XTI =	3	-	FC =	0.73234	-	TNOM	300	K

All parameters are ready to use, no scaling is necessary.

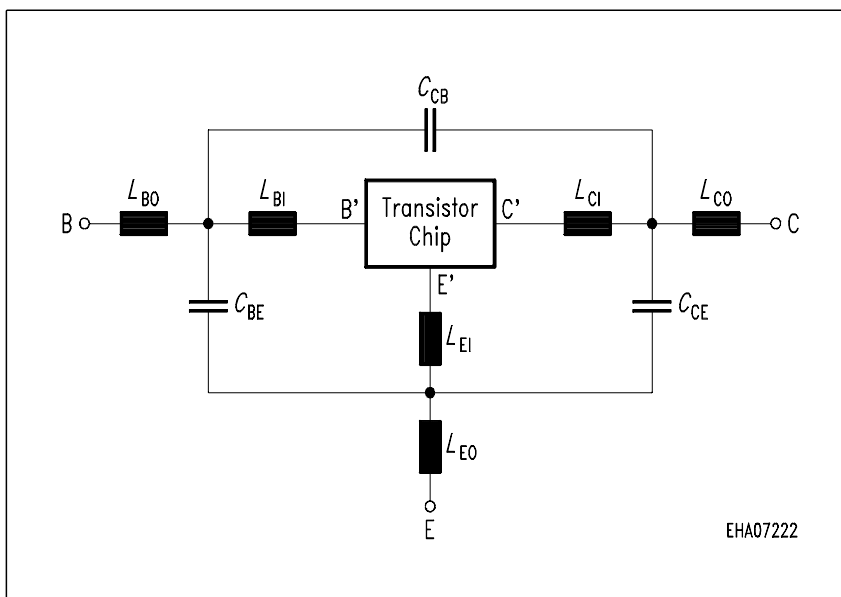
**Package Equivalent Circuit:**

$L_{BI}$ =	0.42	nH
$L_{BO}$ =	0.22	nH
$L_{EI}$ =	0.26	nH
$L_{EO}$ =	0.28	nH
$L_{CI}$ =	0.35	pH
$L_{CO}$ =	0.22	nH
$C_{BE}$ =	34	fF
$C_{BC}$ =	2	fF
$C_{CE}$ =	33	fF
$K_{BO-EO}$ =	0.1	-
$K_{BO-CO}$ =	0.01	-
$K_{EO-CO}$ =	0.11	-
$K_{CI-EI}$ =	-0.05	-
$K_{BI-CI}$ =	-0.08	-
$K_{EI-CI}$ =	0.2	-
$R_{LBI}$ =	0.15	$\Omega$
$R_{LEI}$ =	0.11	$\Omega$
$R_{LCI}$ =	0.13	$\Omega$

Valid up to 6GHz

The TSFP-4 package has two emitter leads. To avoid high complexity of the package equivalent circuit, both lead are combined in on electrical connection.  $R_{LxI}$  are series resistors for the inductance  $L_{xI}$  and  $K_{xa-yb}$  are the coupling coefficients between the inductance  $L_{xa}$  and  $L_{yb}$ . The referencepins for the couple ports are B, E, C, B', E', C'.

For examples and ready to use parameters please contact your local Infineon Technologies distributor or sales office to obtain a Infineon Technologies CD-ROM or see Internet: <http://www.infineon.com/silicondiscretetes>

**Total power dissipation  $P_{tot} = f(T_S)$**

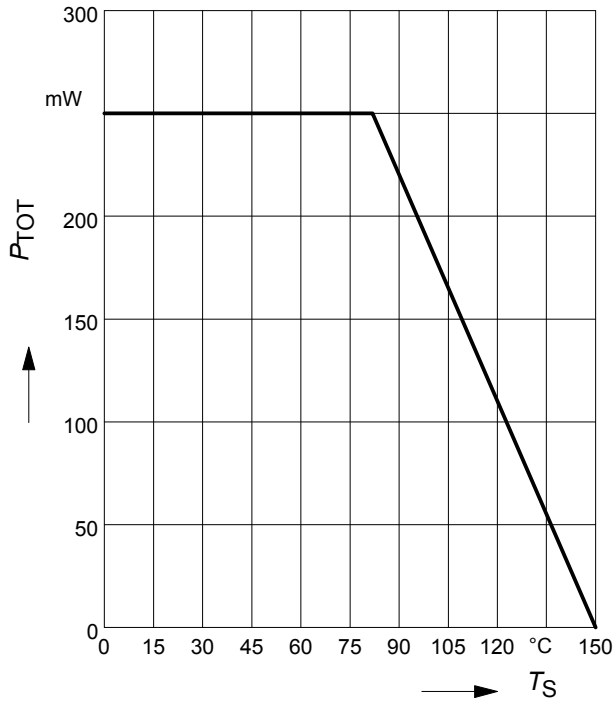

**Permissible Pulse Load  $R_{thJS} = f(t_p)$**

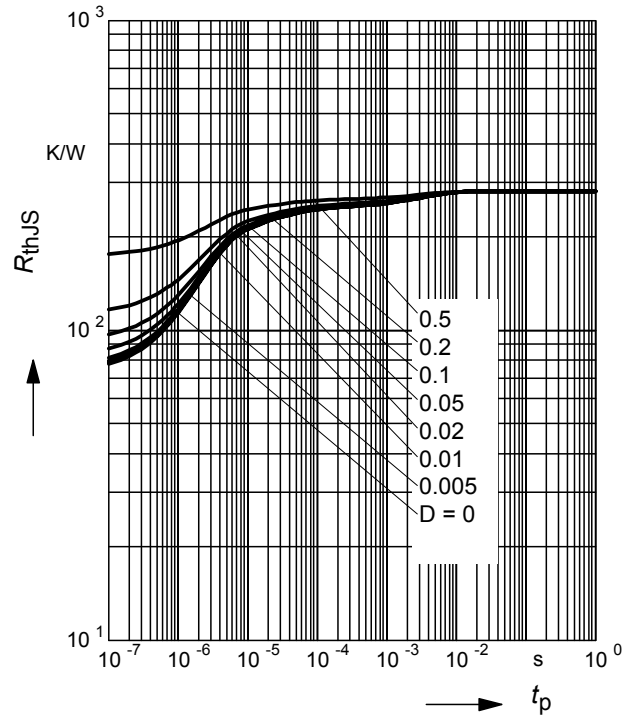

**Permissible Pulse Load**

$P_{totmax}/P_{totDC} = f(t_p)$

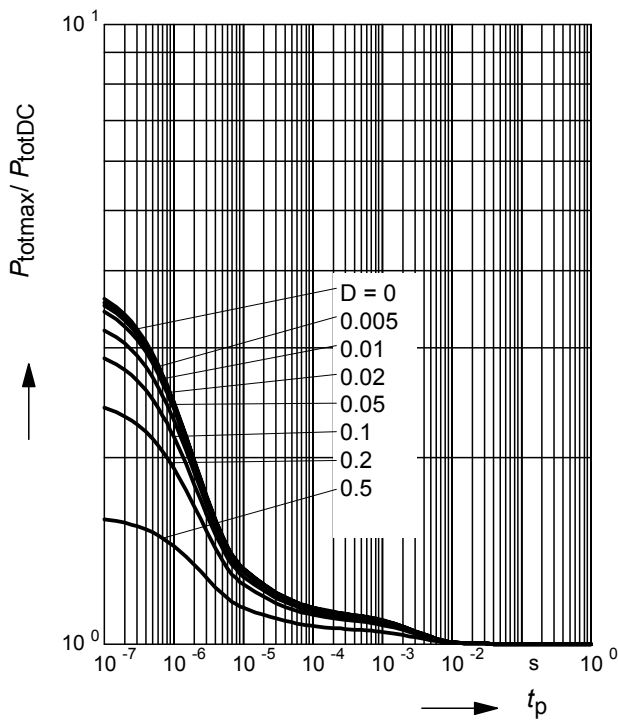

**Collector-base capacitance  $C_{cb} = f(V_{CB})$**

$f = 1\text{MHz}$

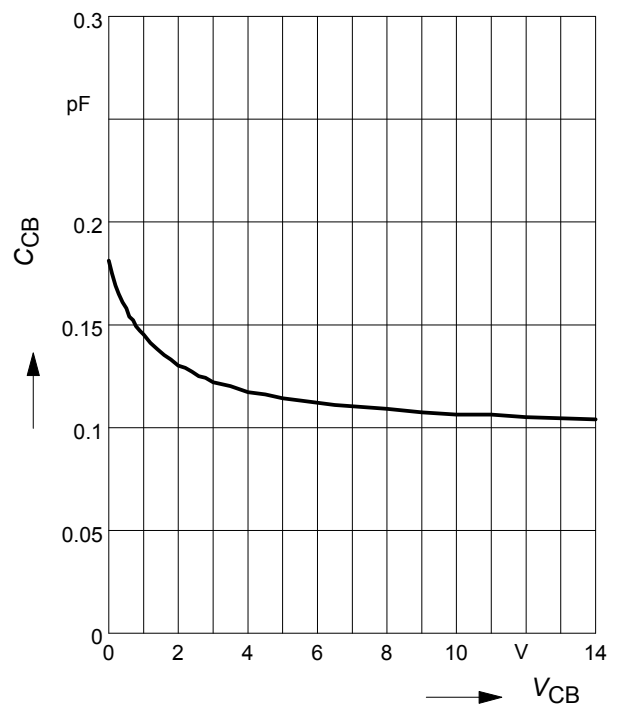

**Transition frequency  $f_T = f(I_C)$**

$f = 1\text{GHz}$

$V_{CE} = \text{Parameter in V}$

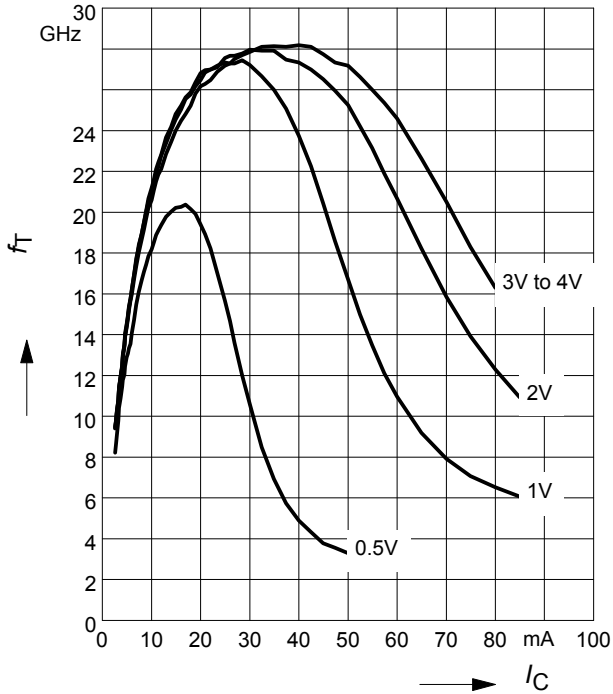

**Power gain  $G_{ma}, G_{ms} = f(I_C)$**

$V_{CE} = 2\text{V}$

$f = \text{Parameter in GHz}$

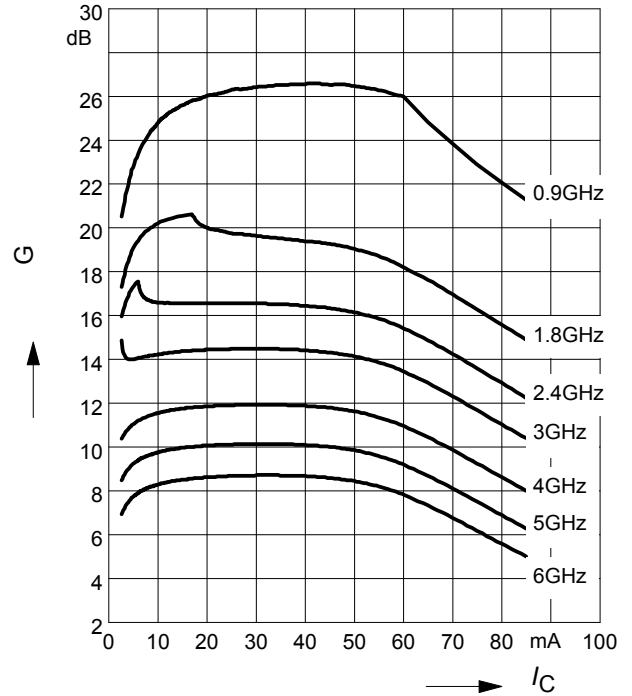

**Power Gain  $G_{ma}, G_{ms} = f(f)$ ,**

$|S_{21}|^2 = f(f)$

$V_{CE} = 2\text{V}, I_C = 20\text{mA}$

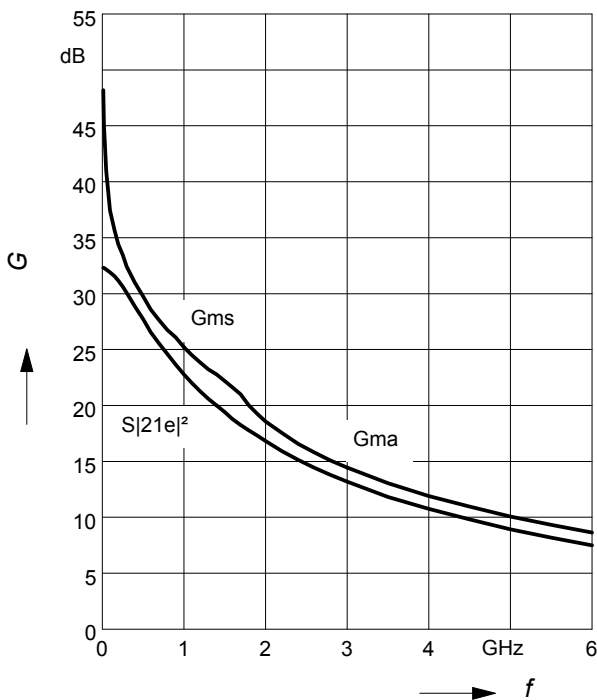

**Power gain  $G_{ma}, G_{ms} = f(V_{CE})$**

$I_C = 20\text{mA}$

$f = \text{Parameter in GHz}$

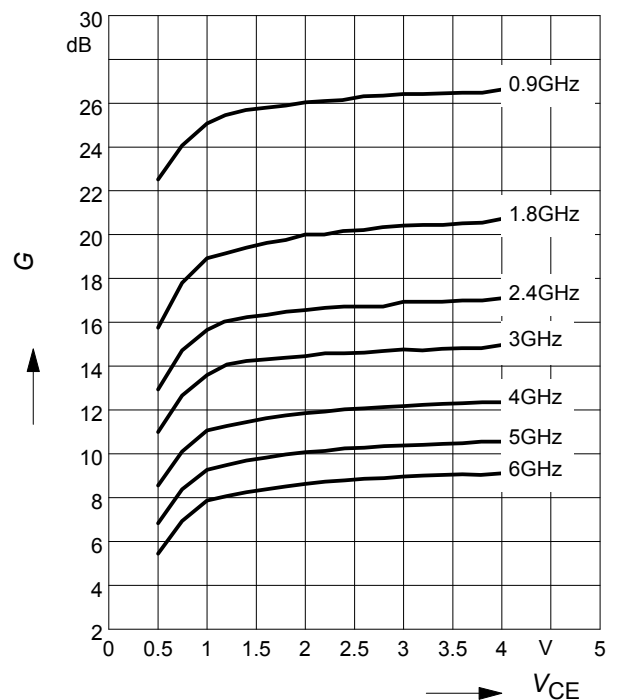

### Package Outline

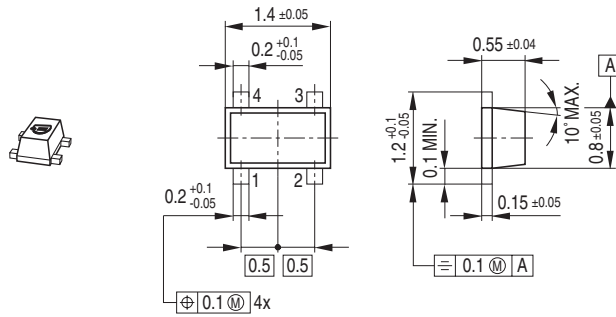

### Foot Print

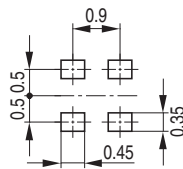

### Marking Layout

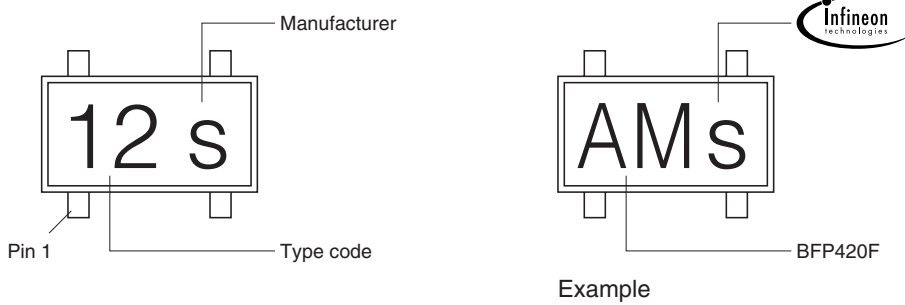

### Packing

Code E6327: Reel  $\varnothing 180$  mm = 3.000 Pieces/Reel  
 Code E6433: Reel  $\varnothing 330$  mm = 10.000 Pieces/Reel

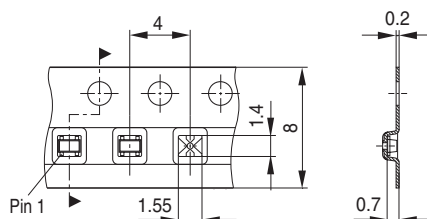

Published by Infineon Technologies AG,  
St.-Martin-Strasse 53,  
81669 München  
© Infineon Technologies AG 2005.  
All Rights Reserved.

### **Attention please!**

The information herein is given to describe certain components and shall not be considered as a guarantee of characteristics.

Terms of delivery and rights to technical change reserved.

We hereby disclaim any and all warranties, including but not limited to warranties of non-infringement, regarding circuits, descriptions and charts stated herein.

### **Information**

For further information on technology, delivery terms and conditions and prices please contact your nearest Infineon Technologies Office ([www.infineon.com](http://www.infineon.com)).

### **Warnings**

Due to technical requirements components may contain dangerous substances. For information on the types in question please contact your nearest Infineon Technologies Office.

Infineon Technologies Components may only be used in life-support devices or systems with the express written approval of Infineon Technologies, if a failure of such components can reasonably be expected to cause the failure of that life-support device or system, or to affect the safety or effectiveness of that device or system. Life support devices or systems are intended to be implanted in the human body, or to support and/or maintain and sustain and/or protect human life. If they fail, it is reasonable to assume that the health of the user or other persons may be endangered.