

Trench gate field-stop IGBT, HB series 650 V, 80 A high speed in TO247-4 package

Datasheet - production data

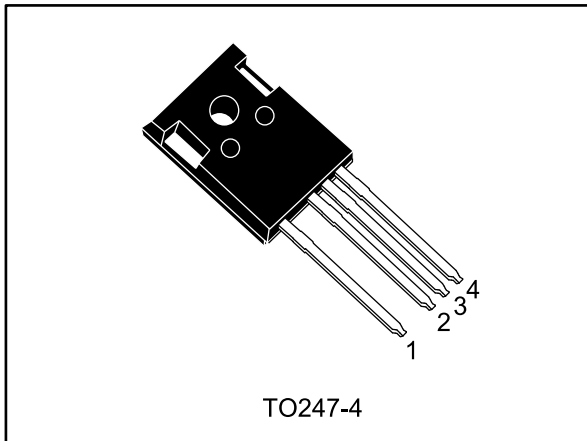
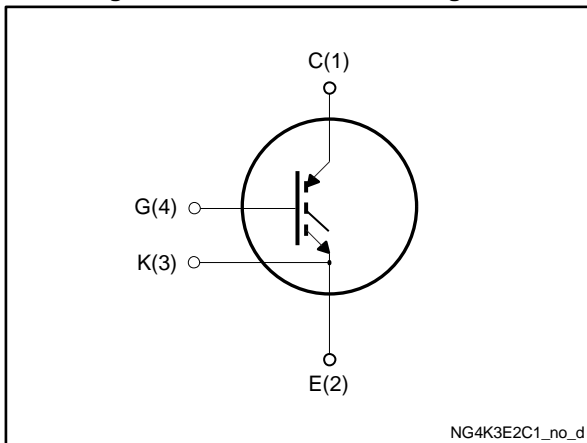

Figure 1: Internal schematic diagram



Features

- $V_{CE(sat)} = 1.6 \text{ V (typ.) @ } I_c = 80 \text{ A}$
- Maximum junction temperature: $T_J = 175 \text{ °C}$
- High speed switching series
- Minimized tail current
- Safe paralleling
- Tight parameter distribution
- Low thermal resistance
- Kelvin pin

Applications

- Photovoltaic inverter
- High frequency converter

Description

This device is an IGBT developed using an advanced proprietary trench gate field-stop structure. The device is part of the new HB series of IGBTs, which represents an optimum compromise between conduction and switching loss to maximize the efficiency of any frequency converter. Furthermore, the slightly positive $V_{CE(sat)}$ temperature coefficient and very tight parameter distribution result in safer paralleling operation.

Table 1: Device summary

Order code	Marking	Package	Packaging
STGW80H65FB-4	G80H65FB	TO247-4	Tube

Contents

1	Electrical ratings	3
2	Electrical characteristics	4
	2.1 Electrical characteristics (curves).....	6
3	Test circuits	10
4	Package information	11
	4.1 TO247-4 package information.....	11
5	Revision history	13

1 Electrical ratings

Table 2: Absolute maximum ratings

Symbol	Parameter	Value	Unit
V_{CES}	Collector-emitter voltage ($V_{GE} = 0$ V)	650	V
I_C	Continuous collector current at $T_C = 25$ °C	120 ⁽¹⁾	A
	Continuous collector current at $T_C = 100$ °C	80	
I_{CP} ⁽²⁾⁽³⁾	Pulsed collector current	300	A
V_{GE}	Gate-emitter voltage	±20	V
P_{TOT}	Total dissipation at $T_C = 25$ °C	469	W
T_{STG}	Storage temperature range	-55 to 150	°C
T_J	Operating junction temperature range	-55 to 175	

Notes:

⁽¹⁾Current level is limited by bond wires.

⁽²⁾Pulse width is limited by maximum junction temperature ($t_p < 1$ ms, $T_J < 175$ °C).

⁽³⁾Defined by design, not tested.

Table 3: Thermal data

Symbol	Parameter	Value	Unit
R_{thJC}	Thermal resistance junction-case	0.32	°C/W
R_{thJA}	Thermal resistance junction-ambient	50	

2 Electrical characteristics

$T_C = 25\text{ °C}$ unless otherwise specified

Table 4: Static characteristics

Symbol	Parameter	Test conditions	Min.	Typ.	Max.	Unit
$V_{(BR)CES}$	Collector-emitter breakdown voltage	$V_{GE} = 0\text{ V}$, $I_C = 2\text{ mA}$	650			V
$V_{CE(sat)}$	Collector-emitter saturation voltage	$V_{GE} = 15\text{ V}$, $I_C = 80\text{ A}$		1.6	2.0	V
		$V_{GE} = 15\text{ V}$, $I_C = 80\text{ A}$, $T_J = 125\text{ °C}$		1.8		
		$V_{GE} = 15\text{ V}$, $I_C = 80\text{ A}$, $T_J = 175\text{ °C}$		1.9		
$V_{GE(th)}$	Gate threshold voltage	$V_{CE} = V_{GE}$, $I_C = 1\text{ mA}$	5	6	7	V
I_{CES}	Collector cut-off current	$V_{GE} = 0\text{ V}$, $V_{CE} = 650\text{ V}$			100	μA
I_{GES}	Gate-emitter leakage current	$V_{CE} = 0\text{ V}$, $V_{GE} = \pm 20\text{ V}$			± 250	nA

Table 5: Dynamic characteristics

Symbol	Parameter	Test conditions	Min.	Typ.	Max.	Unit
C_{ies}	Input capacitance	$V_{CE} = 25\text{ V}$, $f = 1\text{ MHz}$, $V_{GE} = 0\text{ V}$	-	10.5	-	nF
C_{oes}	Output capacitance		-	0.38	-	
C_{res}	Reverse transfer capacitance		-	0.21	-	
Q_g	Total gate charge	$V_{CC} = 520\text{ V}$, $I_C = 80\text{ A}$, $V_{GE} = 0\text{ to }15\text{ V}$ (see Figure 23: "Gate charge test circuit")	-	414	-	nC
Q_{ge}	Gate-emitter charge		-	78	-	
Q_{gc}	Gate-collector charge		-	170	-	

Table 6: IGBT switching characteristics (inductive load)

Symbol	Parameter	Test conditions	Min.	Typ.	Max.	Unit
$t_{d(on)}$	Turn-on delay time	$V_{CE} = 400\text{ V}$, $I_C = 80\text{ A}$, $V_{GE} = 15\text{ V}$, $R_G = 10\ \Omega$ (see Figure 22: "Test circuit for inductive load switching")	-	75	-	ns
t_r	Current rise time		-	35	-	ns
$(di/dt)_{on}$	Turn-on current slope		-	1750	-	A/ μ s
$t_{d(off)}$	Turn-off-delay time		-	336	-	ns
t_f	Current fall time		-	23	-	ns
$E_{on}^{(1)}$	Turn-on switching energy		-	1	-	mJ
$E_{off}^{(2)}$	Turn-off switching energy		-	1.7	-	mJ
E_{ts}	Total switching energy		-	2.7	-	mJ
$t_{d(on)}$	Turn-on delay time	$V_{CE} = 400\text{ V}$, $I_C = 80\text{ A}$, $V_{GE} = 15\text{ V}$, $R_G = 10\ \Omega$, $T_J = 175\text{ }^\circ\text{C}$ (see Figure 22: "Test circuit for inductive load switching")	-	66	-	ns
t_r	Current rise time		-	38	-	ns
$(di/dt)_{on}$	Turn-on current slope		-	1670	-	A/ μ s
$t_{d(off)}$	Turn-off-delay time		-	403	-	ns
t_f	Current fall time		-	45	-	ns
$E_{on}^{(1)}$	Turn-on switching energy		-	1.5	-	mJ
$E_{off}^{(2)}$	Turn-off switching energy		-	2.47	-	mJ
E_{ts}	Total switching energy		-	3.97	-	mJ

Notes:

⁽¹⁾Including the reverse recovery of the external diode. The diode is the same of the co-packed STGW80H65DFB-4.

⁽²⁾Including the tail of the collector current.

2.1 Electrical characteristics (curves)

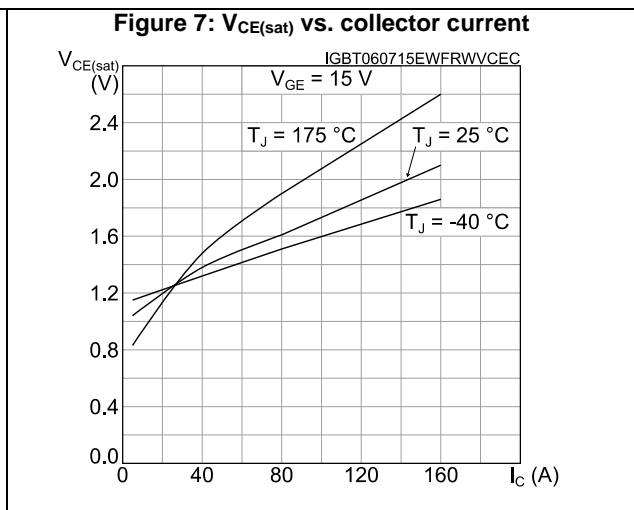
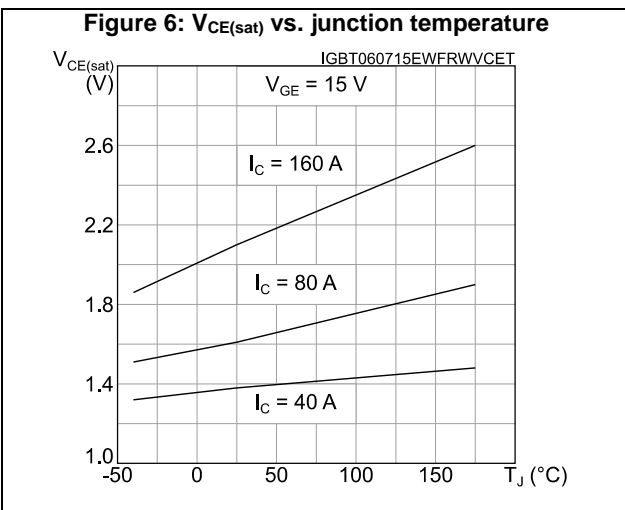
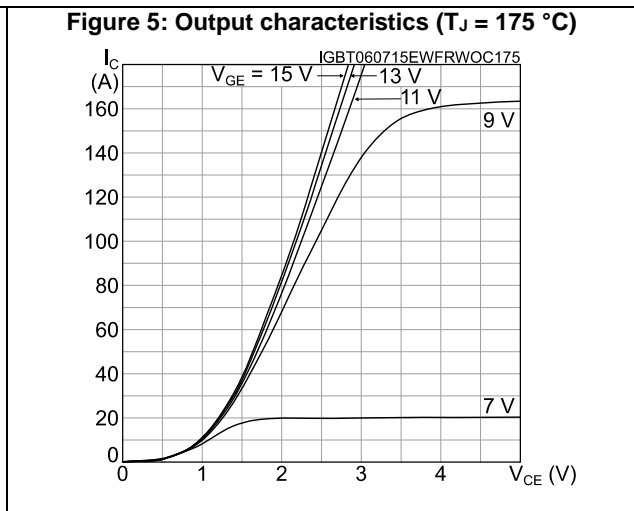
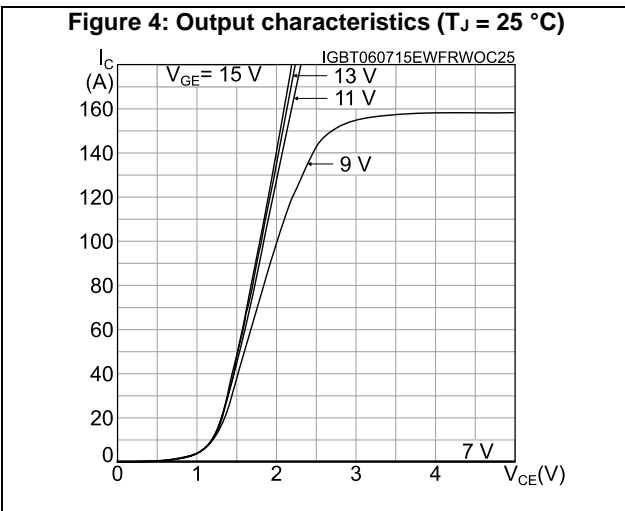
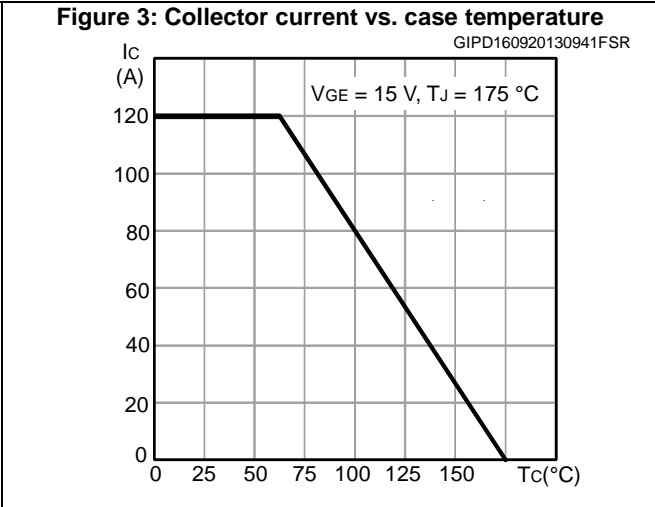
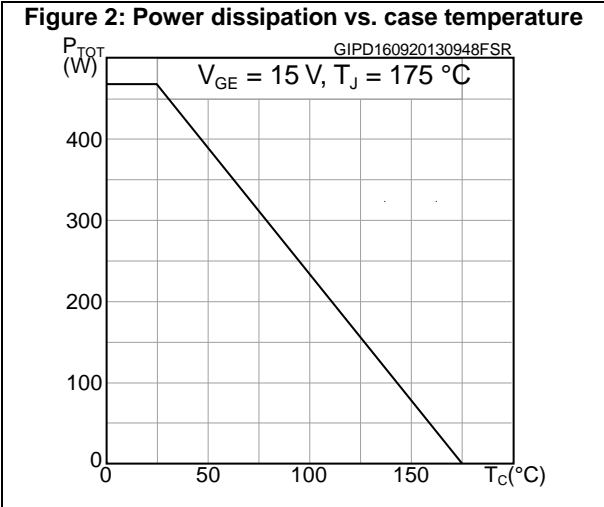

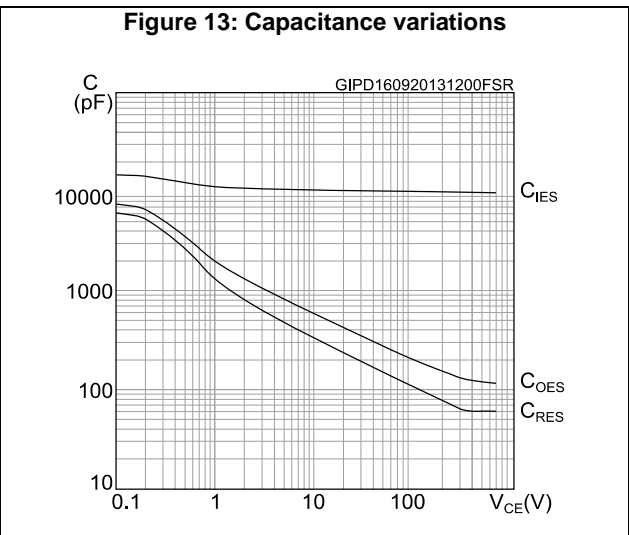
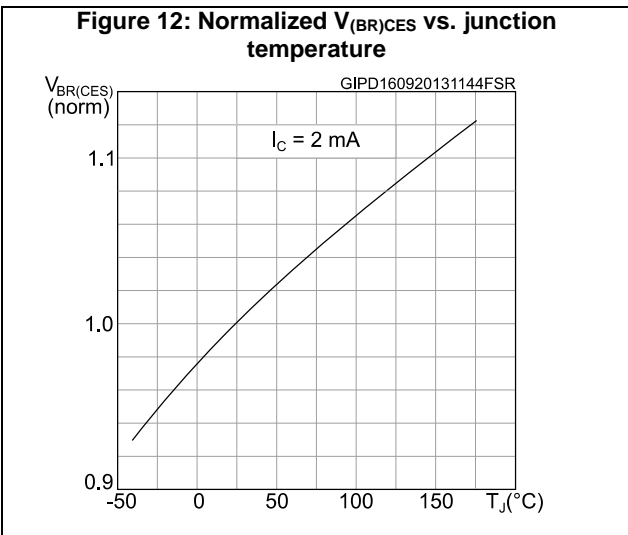
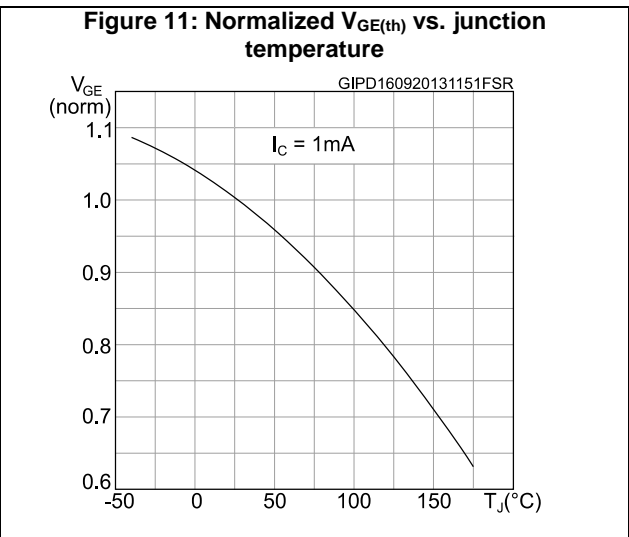
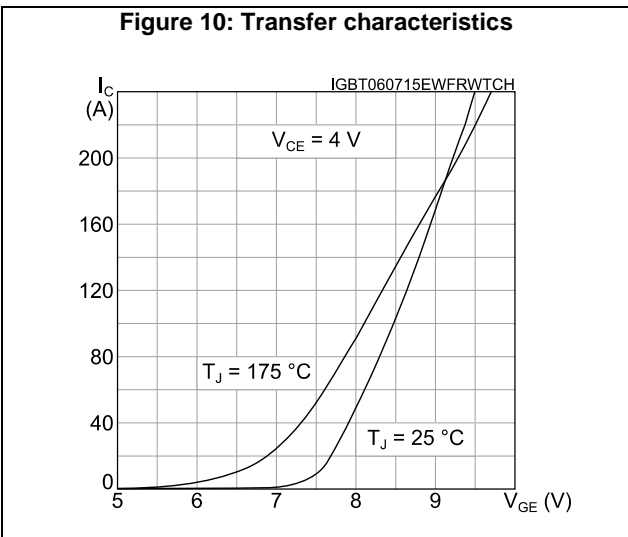
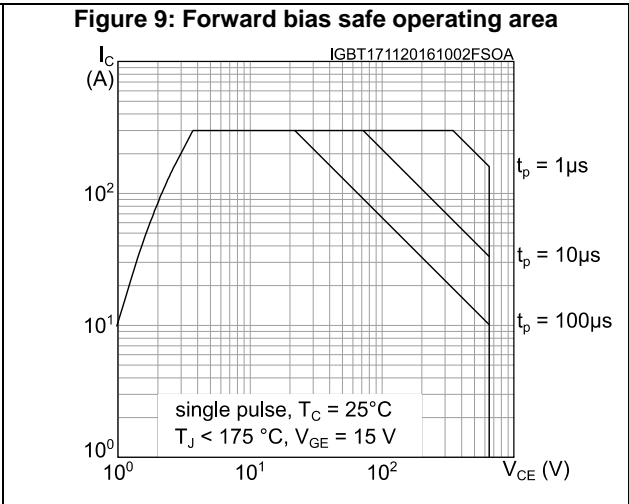
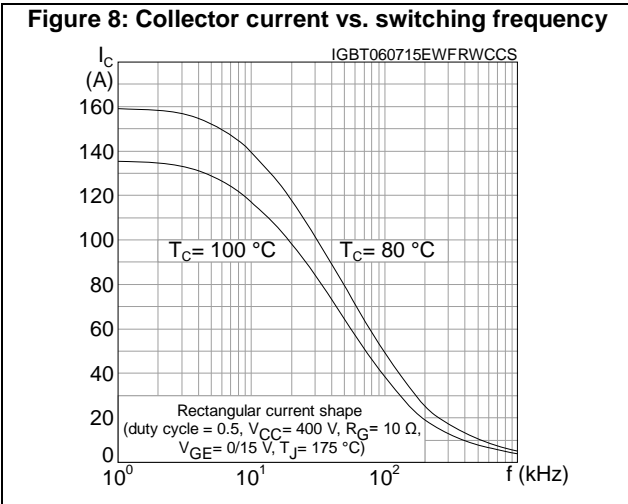

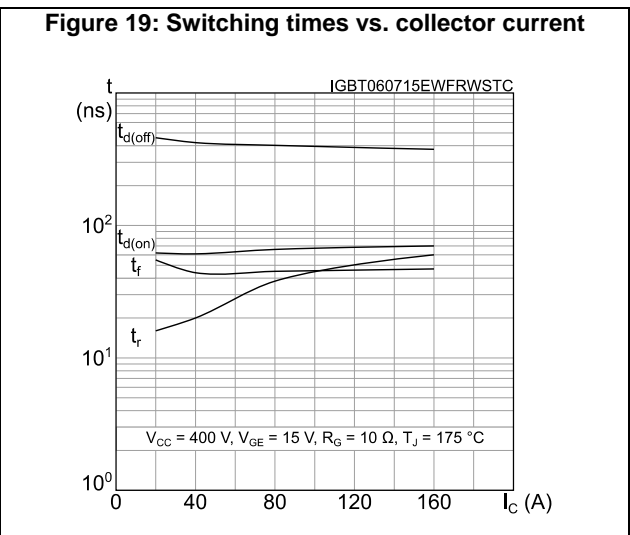
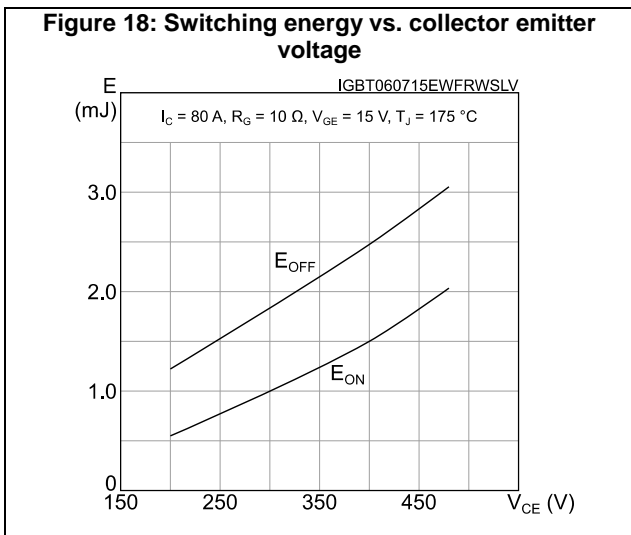
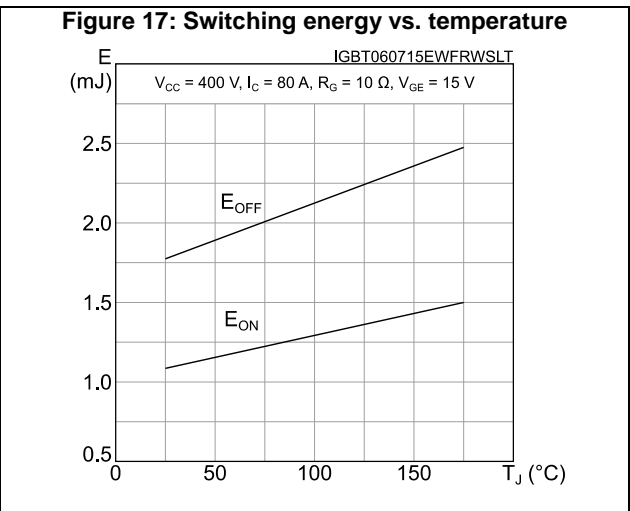
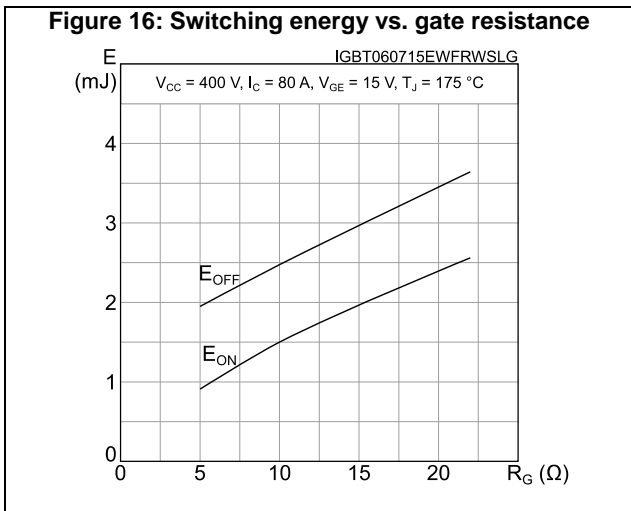
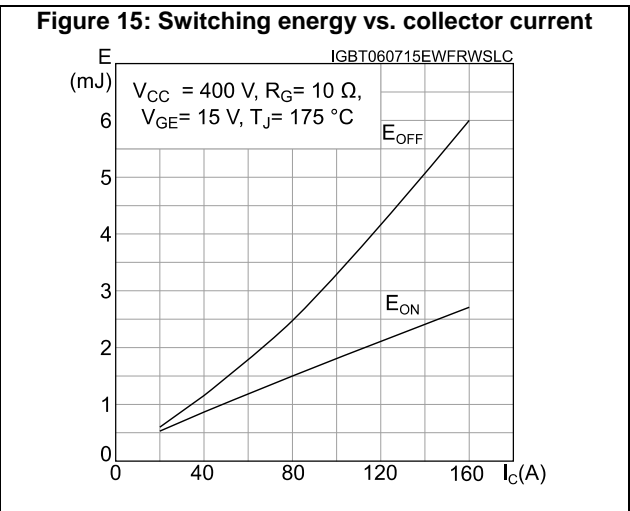
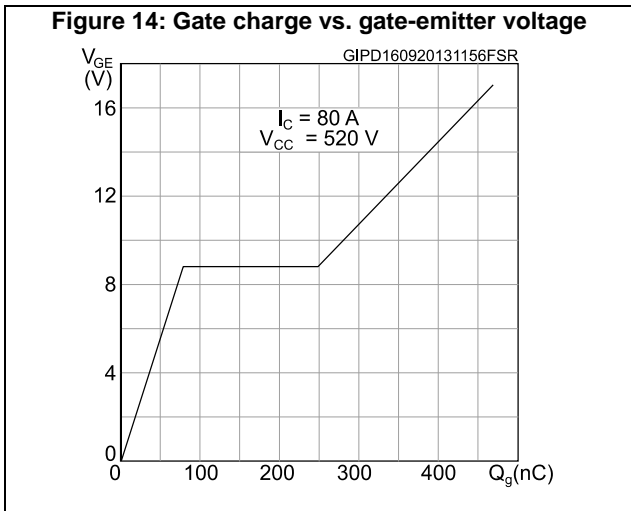

Figure 20: Switching times vs. gate resistance

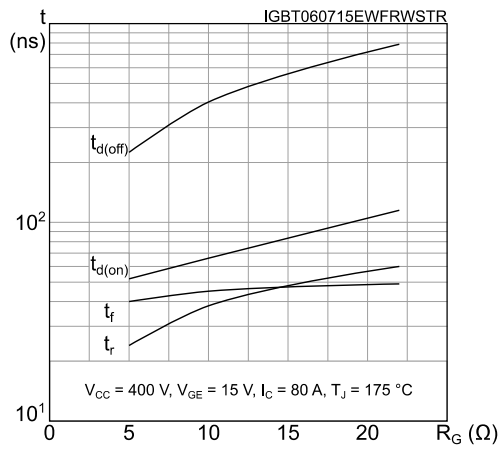
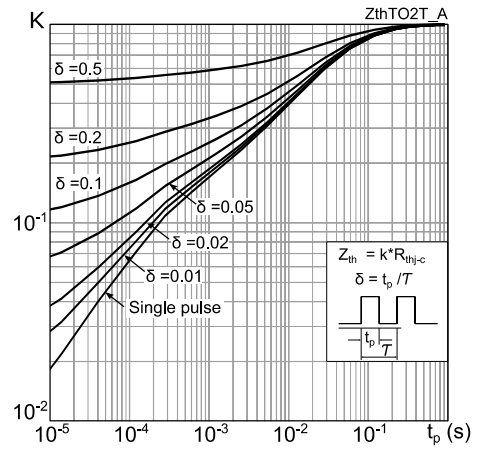
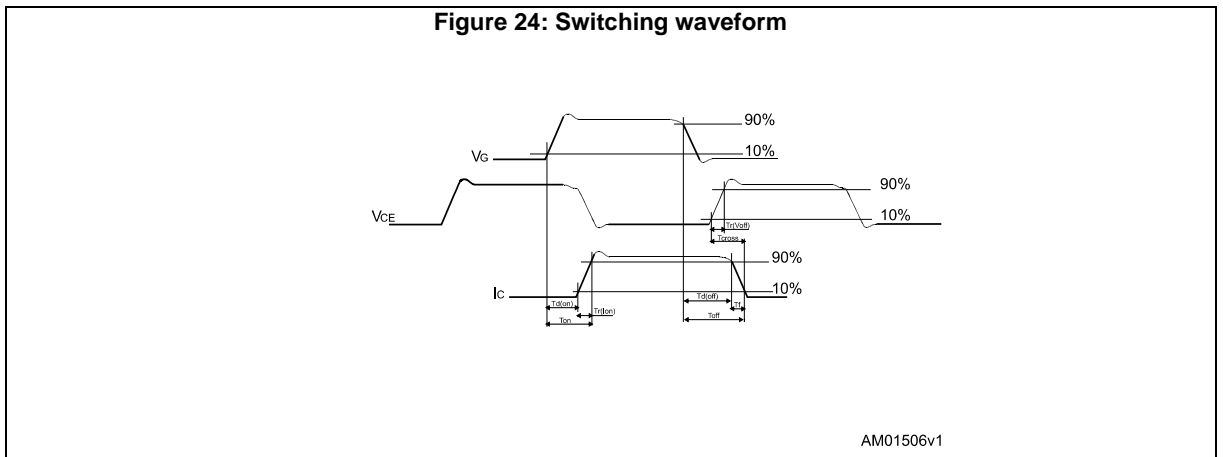
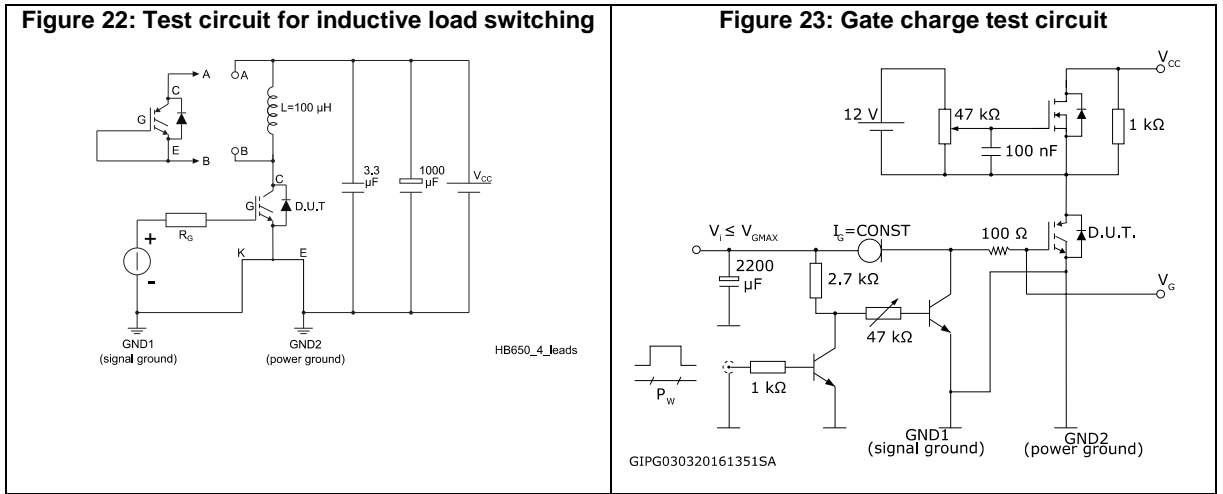

Figure 21: Thermal impedance



3 Test circuits



4 Package information

In order to meet environmental requirements, ST offers these devices in different grades of ECOPACK® packages, depending on their level of environmental compliance. ECOPACK® specifications, grade definitions and product status are available at: www.st.com. ECOPACK® is an ST trademark.

4.1 TO247-4 package information

Figure 25: TO247-4 package outline

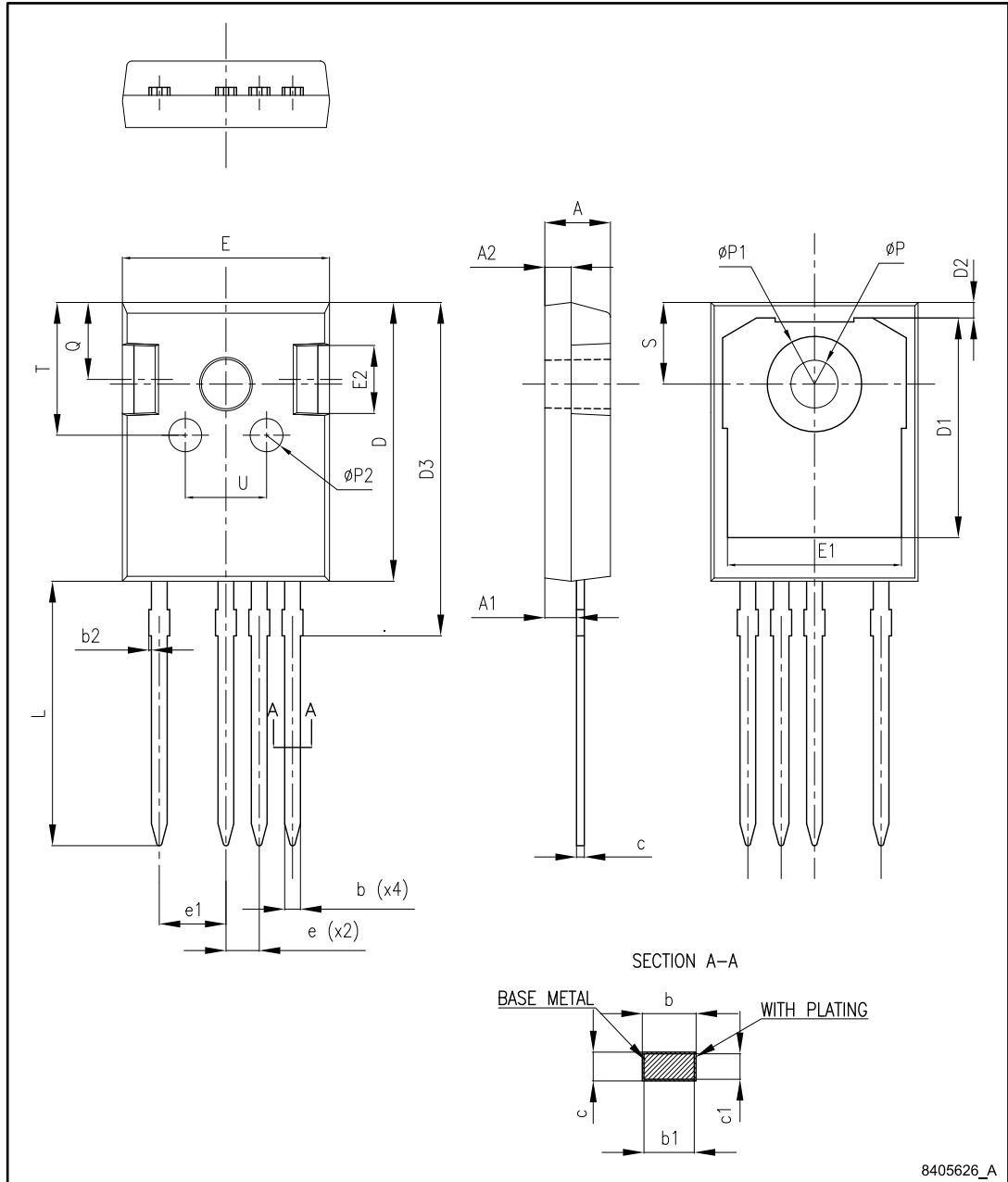

Table 7: TO247-4 mechanical data

Dim.	mm		
	Min.	Typ.	Max.
A	4.90	5.00	5.10
A1	2.31	2.41	2.51
A2	1.90	2.00	2.10
b	1.16		1.29
b1	1.15	1.20	1.25
b2	0		0.20
c	0.59		0.66
c1	0.58	0.60	0.62
D	20.90	21.00	21.10
D1	16.25	16.55	16.85
D2	1.05	1.20	1.35
D3	24.97	25.12	25.27
E	15.70	15.80	15.90
E1	13.10	13.30	13.50
E2	4.90	5.00	5.10
E3	2.40	2.50	2.60
e	2.44	2.54	2.64
e1	4.98	5.08	5.18
L	19.80	19.92	20.10
P	3.50	3.60	3.70
P1			7.40
P2	2.40	2.50	2.60
Q	5.60		6.00
S		6.15	
T	9.80		10.20
U	6.00		6.40

5 Revision history

Table 8: Document revision history

Date	Revision	Changes
13-Apr-2016	1	First release
22-Apr-2016	2	Minor text changes to improve the document readability
03-Apr-2017	3	Updated title and features on cover page. Updated Table 2: "Absolute maximum ratings" . Updated Figure 9: "Forward bias safe operating area" . Minor text changes

IMPORTANT NOTICE – PLEASE READ CAREFULLY

STMicroelectronics NV and its subsidiaries ("ST") reserve the right to make changes, corrections, enhancements, modifications, and improvements to ST products and/or to this document at any time without notice. Purchasers should obtain the latest relevant information on ST products before placing orders. ST products are sold pursuant to ST's terms and conditions of sale in place at the time of order acknowledgement.

Purchasers are solely responsible for the choice, selection, and use of ST products and ST assumes no liability for application assistance or the design of Purchasers' products.

No license, express or implied, to any intellectual property right is granted by ST herein.

Resale of ST products with provisions different from the information set forth herein shall void any warranty granted by ST for such product.

ST and the ST logo are trademarks of ST. All other product or service names are the property of their respective owners.

Information in this document supersedes and replaces information previously supplied in any prior versions of this document.

© 2017 STMicroelectronics – All rights reserved